

# OWNER'S MANUAL

# FAX-885MC

---

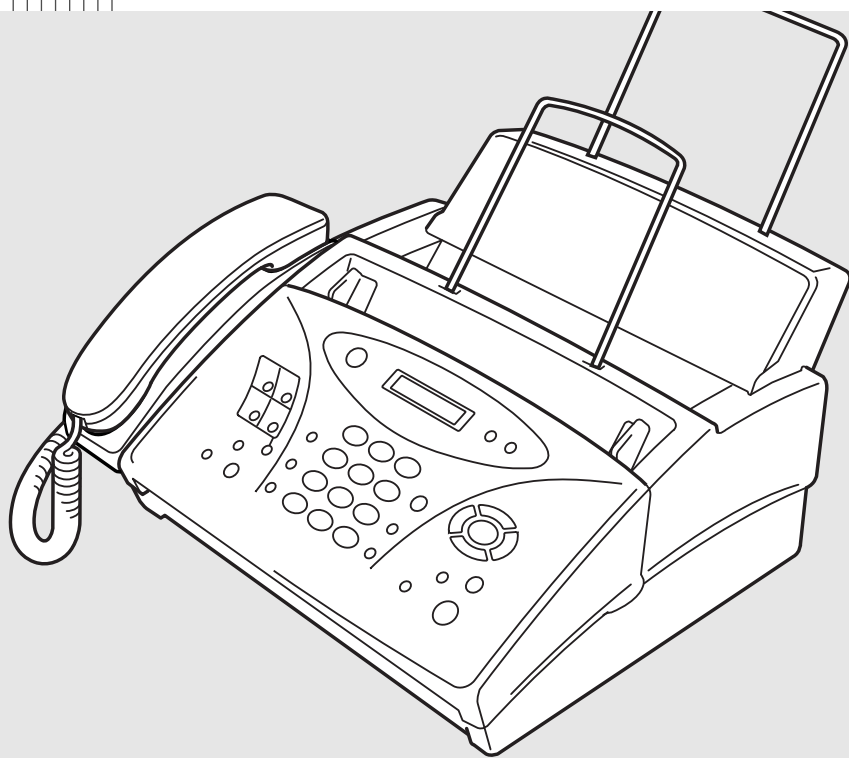

## **If You Need to Call Customer Service**

**Please complete the following information for future reference:**

**Model: FAX-885MC**

**Serial Number:\*** \_\_\_\_\_

**Date of Purchase:** \_\_\_\_\_

**Place of Purchase:** \_\_\_\_\_

**\* The serial number is on the underside of the unit. Retain this Quick-Start Manual with your sales receipt as a permanent record of your purchase, in the event of a theft, fire or warranty service.**

# Brother Numbers

---

## IMPORTANT NOTE:

**For technical and operational assistance, you must call the country where you purchased the fax machine. Calls must be made *from within* that country.**

## Brother fax-back system

Brother Customer Service has installed an easy-to-use fax-back system, so you can get instant answers to common technical questions and product information for all Brother products. This system is available 24 hours a day, 7 days a week. You can use the system to send faxes to any fax machine, not just the one from which you are calling.

If you can't resolve difficulty with your fax machine using this manual, call our fax-back system, and follow the voice prompts to receive faxed instructions about using the system, and an index of fax-back subjects.

**In USA:** 1-800-521-2846  
**In Canada:** 1-800-681-9838  
1-514-685-5381 (in Montreal)

The Brother fax-back system number (For USA Only) has been preprogrammed on One Touch key **1**.

## Frequently Asked Questions (FAQs)

You can find more information about Brother products on the World Wide Web. From product specification sheets to Frequently Asked Questions (FAQs), it is all there. Visit us at:

<http://www.brother.com>

## For Customer Service

**In USA:** 1-800-284-4329 (voice)  
1-908-575-8790 (fax)  
1-800-284-3238 (TTY service for the hearing-impaired)  
**In Canada:** 1-800-853-6660 (voice)  
1-514-685-4898 (fax)  
1-514-685-6464 (voice) (in Montreal)

## Dealers/Service Centers (For USA Only)

For the name of a Brother authorized dealer or service center, call 1-800-284-4357.

## Service Centers (For Canada Only)

For service center addresses in Canada, call 1-800-853-6660.

# Ordering Accessories and Supplies

## IMPORTANT NOTE:

**For technical and operational assistance, you must call the country where you purchased the fax machine. Calls must be made *from within* that country.**

For the best quality results use only genuine Brother accessories, available at most Brother retailers. If you cannot find the accessory you need and you have a Visa, MasterCard, Discover or American Express credit card, you can order accessories directly from Brother.

**In USA:** 1-888-879-3232 (voice)  
1-800-947-1445 (fax)

**In Canada:** 1-800-668-2768 (voice)

DESCRIPTION	ITEM
Thermal Print Cartridge	PC301
1-PK Refill Roll (For Canada Only)	PC300RF
2-PK Refill Rolls	PC302RF
4-PK Refill Rolls	PC304RF
Telephone Line Cord	LG3077001
Telephone Handset	LE0446011
Handset Curled Cord	UG3543011
Document Tray	UF5607000
Paper Support Wire	UF9869001
Owner's Manual	LE5329001
Surge Protection Device with Telephone Line Protection (2 outlets)	QPD 120
Surge Protection Device with Telephone Line Protection (8 outlets)	FX 120

## **Notice – Disclaimer of Warranties (For USA and Canada)**

BROTHER'S LICENSOR(S), AND THEIR DIRECTORS, OFFICERS, EMPLOYEES OR AGENTS (COLLECTIVELY BROTHER'S LICENSOR) MAKES NO WARRANTIES, EXPRESS OR IMPLIED, INCLUDING WITHOUT LIMITATION THE IMPLIED WARRANTIES OF MERCHANTABILITY AND FITNESS FOR A PARTICULAR PURPOSE, REGARDING THE SOFTWARE. BROTHER'S LICENSOR(S) DOES NOT WARRANT, GUARANTEE OR MAKE ANY REPRESENTATIONS REGARDING THE USE OR THE RESULTS OF THE USE OF THE SOFTWARE IN TERMS OF ITS CORRECTNESS, ACCURACY, RELIABILITY, CURRENTNESS OR OTHERWISE. THE ENTIRE RISK AS TO THE RESULTS AND PERFORMANCE OF THE SOFTWARE IS ASSUMED BY YOU. THE EXCLUSION OF IMPLIED WARRANTIES IS NOT PERMITTED BY SOME STATES IN THE USA AND SOME PROVINCES IN CANADA. THE ABOVE EXCLUSION MAY NOT APPLY TO YOU.

IN NO EVENT WILL BROTHER'S LICENSOR(S) BE LIABLE TO YOU FOR ANY CONSEQUENTIAL, INCIDENTAL OR INDIRECT DAMAGES (INCLUDING DAMAGES FOR LOSS OF BUSINESS PROFITS, BUSINESS INTERRUPTION, LOSS OF BUSINESS INFORMATION, AND THE LIKE) ARISING OUT OF THE USE OR INABILITY TO USE THE SOFTWARE EVEN IF BROTHER'S LICENSOR HAS BEEN ADVISED OF THE POSSIBILITY OF SUCH DAMAGES. BECAUSE SOME STATES IN THE USA AND SOME PROVINCES IN CANADA DO NOT ALLOW THE EXCLUSION OR LIMITATION OF LIABILITY FOR CONSEQUENTIAL OR INCIDENTAL DAMAGES, THE ABOVE LIMITATIONS MAY NOT APPLY TO YOU. IN ANY EVENT BROTHER'S LICENSOR'S LIABILITY TO YOU FOR ACTUAL DAMAGES FROM ANY CAUSE WHATSOEVER, AND REGARDLESS OF THE FORM OF THE ACTION (WHETHER IN CONTRACT, TORT (INCLUDING NEGLIGENCE), PRODUCT LIABILITY OR OTHERWISE), WILL BE LIMITED TO \$50.

## **Compilation and Publication Notice**

Under the supervision of Brother Industries, Ltd., this manual has been compiled and published, covering the latest product descriptions and specifications.

The contents of this manual and the specifications of this product are subject to change without notice.

Brother reserves the right to make changes without notice in the specifications and materials contained herein and shall not be responsible for any damages (including consequential) caused by reliance on the materials presented, including but not limited to typographical and other errors relating to the publication.

## **Trademarks**

The Brother logo is a registered trademark of Brother Industries, Ltd.

Brother is a registered trademark of Brother Industries, Ltd.

IBM, IBM PC, MWAVE and IBM Aptiva are registered trademarks of International Business Machines Corporation.

Microsoft and MS-DOS are registered trademarks of Microsoft Corporation.

Windows and Windows NT are registered trademarks of Microsoft in the U.S. and other countries.

**All other terms and brand and product names mentioned in this manual are registered trademarks of their respective companies.**

## BROTHER ONE YEAR LIMITED WARRANTY and EXCHANGE SERVICE (For USA Only)

This warranty gives you certain rights and you may also have other rights that may vary from state to state.

This warranty is given only to the first end-use purchaser of the accompanying product (referred to in this warranty as "this Product").

**What is covered:** Brother warrants to you for the Warranty Period that there are no defects in the materials, workmanship or Year 2000 compliance of this Product. The "Warranty Period" is 1 year from the date you purchased this product. The "Warranty Period" for consumable items, such as Print Heads, Toner, Drums, Ink Cartridges, Print Cartridges, Refill Ribbons, Therma PLUS Paper and Thermal Paper, etc. is 90 days from the date of purchase, or the rated life of the Consumable item, whichever is shorter.

**What is NOT covered:** This warranty is VOID -- that is, this Product has no warranty -- if: (1) you did not purchase this Product from an authorized Brother reseller within the United States, (2) this Product has been serviced, modified or tampered with by anyone other than an Authorized Service Representative of Brother, (3) the serial number has been modified, defaced or removed from this Product, (4) this Product has been abused or damaged, or, the recommended monthly volume has been exceeded, (5) non Brother<sup>®</sup>-brand or non Brother approved parts, supplies, power supplies or other accessories have been used with this Product, or (6) this Product has been transported without the proper preparation and packaging.

**What to do if you think your Product is defective:** Call our Customer Service Hotline at 1-800-284-4329, or if you suspect a defect in materials or workmanship in this Product, you can report it to a Brother Authorized Service Center. During the Warranty Period, supply Brother's representative with a copy of your dated bill of sale showing that this Product was purchased within the United States. For the name of your Brother Authorized Service Center, call 1-800-521-2846. After contacting the

Brother Authorized Service Center, you may be required to deliver or send the Product properly packaged, freight prepaid, to the Authorized Service Center together with a photocopy of your bill of sale.

**What Brother will do:** Brother (or its Authorized Service Center) will evaluate your report of a possible defect to determine whether a defect exists, and if it does exist, Brother (or its Authorized Service Center) will repair or (at Brother's option) replace the Product with a product that performs the same functions and performs as well as the original Product. Brother reserves the right to supply refurbished or remanufactured replacement parts provided that the replacement parts conform to the manufacturer's specifications for new products. The repaired or replacement product will be returned to you at no cost.

**Exchange Service:** When an exchange is authorized, Brother will exchange your non-working product with a refurbished or remanufactured product that conforms to the manufacturer's specifications for new products. The refurbished or remanufactured Product you receive will be covered by the balance of the limited warranty period remaining on the original Product, plus an additional thirty (30) days. You will keep the replacement Product that is sent to you and must return (or be billed up to the cost of a new product) your original non-working product, which shall become the property of Brother. You must call Brother Customer Service and if the representative cannot correct the product's malfunction over the telephone and you elect the exchange service, you must provide information pertaining to this Product and you must also provide a valid major credit card number. Your credit card will be charged up to the cost of a new Product if: (i) you do not return your original Product to Brother within five (5) business days; (ii) the malfunctions of your original Product are not covered by the limited warranty;

## BROTHER ONE YEAR LIMITED WARRANTY and EXCHANGE SERVICE (For USA Only)

(iii) the proper packaging instructions are not followed and has caused damage to the product; or (iv) the warranty period on your original Product has expired or has not been sufficiently validated with a copy of the proof of purchase (bill of sale). The Brother Customer Service Representative will ship the exchange Product via next business day delivery courier service, with return instructions and prepaid return air bill. Follow the return instructions. You must return the original Product in the same shipping carton in which the exchanged Product was received and include a copy of proof of purchase (bill of sale). Retain your original accessory items and a copy of the return air bill, signed by the courier.

**Limitations:** Repair or replacement as described above is your sole and exclusive (that is, your only) remedy if this Product is defective. Brother is not responsible for damage to or loss of any equipment, media, programs or data related to the use of this Product. Except for that repair or replacement, *Brother shall not be liable for any direct, indirect, incidental or consequential damages or specific relief. Because some states do not allow the exclusion or limitation of consequential or incidental damages, the above limitation may not apply to you.*

THIS WARRANTY IS GIVEN IN LIEU OF ALL OTHER WARRANTIES, WRITTEN OR ORAL, WHETHER EXPRESSED BY AFFIRMATION, PROMISE, DESCRIPTION, DRAWING, MODEL OR SAMPLE. ANY AND ALL WARRANTIES OTHER THAN THIS ONE, WHETHER EXPRESS OR IMPLIED, INCLUDING IMPLIED WARRANTIES OF MERCHANTABILITY AND FITNESS FOR A PARTICULAR PURPOSE, ARE HEREBY DISCLAIMED.

This Limited Warranty is the only warranty that Brother is giving for this Product. It is the *final expression and the exclusive and only statement* of Brother's obligations to you. It replaces all other agreements and understandings that

you may have with Brother or its representatives.

This Limited Warranty (and Brother's obligation to you) may not be changed in any way unless you and Brother sign the same piece of paper in which we (1) refer to this Product and your bill of sale date, (2) describe the change to this warranty and (3) agree to make that change.

**Product Support:** Toll-free customer service and technical support is available for hardware operational assistance at 1-800-284-4329. At any time, free technical support in the form of Frequently Asked Questions, troubleshooting tips and service center locator is available through our fax-back system at 1-800-521-2846 or Brother's Internet Web Site ([www.brother.com](http://www.brother.com)). Now you can visit us on-line at ([www.brothermall.com](http://www.brothermall.com)), your complete source for genuine Brother Accessories and Supplies.

**BROTHER INTERNATIONAL CORPORATION  
100 SOMERSET CORPORATE BLVD.  
BRIDGEWATER, NEW JERSEY 08807-0911**

Please record your model and serial numbers and your date and location of Purchase below for your records. Keep this information with your proof of purchase (bill of sale) in case your Product is lost, stolen or requires service.

Model #

Serial #

Date of purchase:

Store where purchased:

Location of store:

**Important:** *We recommend that you keep all original packing materials, in the event that you ship this product.*

**BROTHER MULTIFUNCTION CENTER/FACSIMILE MACHINE  
LIMITED WARRANTY  
(For Canada Only)**

Pursuant to this limited warranty of 1 year from the date of purchase for labour and parts, Brother International Corporation (Canada) Ltd. ("Brother"), or its Authorized Service Centers, will repair this MFC/Facsimile machine free of charge if defective in material or workmanship. This Limited Warranty does not include cleaning, consumables (including, without limitation, print cartridges, print head, toner and drum) or damage caused by accident, neglect, misuse or improper installation or operation, any damage caused from service, maintenance, modifications, or tampering by anyone other than a Brother Authorized Service Representative, or from the use of supplies or consumable items that are non-Brother products. Operation of the MFC/Facsimile machine in excess of the specifications or with the Serial Number or Rating Label removed shall be deemed abuse and all repairs thereafter shall be the sole liability of the end-user/purchaser. In order to obtain warranty service, the MFC/Facsimile machine must be delivered or shipped freight prepaid by the end user/purchaser to a "Brother" Authorized Service Center, together with your Proof of Purchase in the form of a Sales Receipt.

For laser products: Failure to remove the Toner Cartridge (and Toner Drum Unit on applicable models) during shipping will cause severe damage to the MFC/Facsimile and will VOID the Warranty. (Refer to your Operation Manual for proper packaging.)

For ink-jet products: Do not remove the ink cartridges during shipping. Damage to your print head resulting from packing without the ink cartridges will VOID your warranty. (Refer to your Operation Manual for proper packaging.)

BROTHER DISCLAIMS ALL OTHER WARRANTIES EXPRESSED OR IMPLIED INCLUDING, WITHOUT LIMITATION, ANY IMPLIED WARRANTIES OF MERCHANTABILITY OR FITNESS FOR A PARTICULAR PURPOSE, EXCEPT TO THE EXTENT THAT ANY WARRANTIES IMPLIED BY LAW CANNOT BE VALIDLY WAIVED.

No oral or written information, advice or representation provided by Brother, its Authorized Service Centers, Distributors, Dealers, Agents or employees, shall create another warranty or modify this warranty. This warranty states Brother's entire liability and your exclusive remedy against Brother for any failure of the MFC/Facsimile machine to operate properly.

Neither Brother nor anyone else involved in the development, production, or delivery of this MFC/Facsimile machine shall be liable for any indirect, incidental, special, consequential, exemplary, or punitive damages, including lost profits, arising from the use of or inability to use the product, even if advised by the end user/purchaser of the possibility of such damages. Since some Provinces do not allow the above limitation of liability, such limitation may not apply to you.

This Limited Warranty gives you specific legal rights and you may also have other rights which vary from Province to Province.

**Warranty Service is available at Brother Authorized Service Centers throughout Canada. For Technical Support or for the name and location of your nearest Authorized Service Center call 1-800-853-6660. Within Montreal, please call 685-6464. Internet support: [support@brother.ca](mailto:support@brother.ca) or browse Brother's Web Site: [www.brother.com](http://www.brother.com)**

Brother International Corporation (Canada) Ltd.  
1 Rue Hôtel de Ville  
Dollard-Des-Ormeaux, QC H9B 3H6





# Table of Contents

---

## 1

<b>Introduction .....</b>	<b>1-1</b>
Using This Manual .....	1-1
Finding Information.....	1-1
Conventions Used in this Manual.....	1-1
FAX-885MC Control Panel Overview .....	1-2
About Fax Machines .....	1-4
Custom Features .....	1-4
Do You Have Voice Mail on the Phone Line? .....	1-4
Why Should There Be Trouble? .....	1-4
How Can You Avoid Possible Problems? .....	1-4
Fax Tones and Handshake.....	1-4
ECM (Error Correction Mode).....	1-5
Test Sheet Procedure and Product Registration (For USA Only).....	1-5

## 2

<b>Location and Connections .....</b>	<b>2-1</b>
Caution .....	2-1
Choosing a Location.....	2-1
Packing List.....	2-2
Assembly.....	2-3
Attach the Document Support .....	2-3
Attach the Paper Wire Extension .....	2-3
Load the Paper.....	2-4
Acceptable Paper .....	2-4
Connections .....	2-5
Connecting the Machine.....	2-5
Special Line Considerations .....	2-6
Roll Over Phone Lines.....	2-6
Two-Line Phone System.....	2-6
Converting Telephone Wall Outlets .....	2-6
Installing Brother Machine, External Two-Line TAD and Two-Line Telephone.....	2-7
Multi-Line Connections (PBX) .....	2-7
If You Are Installing the Fax Machine to Work with a PBX: .....	2-8
Custom Features on Your Phone Line.....	2-8

Connecting an External Telephone Answering Device (TAD).....	2-9
Sequence .....	2-9
Connections.....	2-10
Outgoing Message (OGM) on an External TAD .....	2-10
Connecting an External Telephone.....	2-10

### 3

<b>On-Screen Programming.....</b>	<b>3-1</b>
User-Friendly Programming.....	3-1
Menu Selection Table.....	3-1
Alternating Displays .....	3-1
Navigation Keys .....	3-2

### 4

<b>Initial Setup.....</b>	<b>4-1</b>
Getting Started.....	4-1
Setting Date and Time .....	4-1
Setting Station ID .....	4-1
Details for Entering Text.....	4-2
Inserting Spaces .....	4-2
Making Corrections.....	4-3
Repeating Letters .....	4-3
Special Characters and Symbols .....	4-3
Setting the Speaker Volume .....	4-4
Choosing the Handset Volume (For Volume Amplify) .....	4-4
Setting Volume Amplify .....	4-5
Setting the Ring Volume .....	4-5
Setting Beeper Volume.....	4-5
Memory Storage .....	4-6
Setting Tone/Pulse Dialing Mode (For Canada Only) .....	4-6
Setting Up Your Area Code (For USA Only) .....	4-6

### 5

<b>Setup Receive.....</b>	<b>5-1</b>
Basic Receiving Operations .....	5-1
Select Receive Mode .....	5-1
Setting Ring Delay .....	5-2
Setting F/T Ring Time.....	5-3
Record FAX/TEL Outgoing Message (F/T OGM) .....	5-3
Easy Receive .....	5-4
Printing a Reduced Incoming Original.....	5-4
Recommended Reductions.....	5-5

Setting Paper Size.....	5-5
Advanced Receiving Operations .....	5-6
Operation from External or Extension Telephone.....	5-6
For FAX/TEL Mode Only .....	5-6
Changing Remote Codes.....	5-6
To Change Remote Codes .....	5-6
Polling.....	5-7

## 6

<b>Setup Send .....</b>	<b>6-1</b>
Automatic Document Feeder (ADF).....	6-1
Manual Transmission .....	6-2
Automatic Transmission.....	6-2
Manual and Automatic Fax Redial.....	6-2
Quick Scan Fax Transmission.....	6-3
Basic Sending Operations .....	6-3
Contrast.....	6-3
Resolution.....	6-3
Advanced Sending Operations .....	6-4
Overseas Mode .....	6-4
Delayed FAX.....	6-4
Setting Up for Polled Transmit.....	6-5
Canceling a Scheduled Job.....	6-5
Interrupting Delayed Fax and Polled Transmit Jobs .....	6-5
Features That Are Not in the Manual (Call Brother fax-back system) .....	6-6

## 7

<b>Auto Dial Numbers and Dialing Options.....</b>	<b>7-1</b>
Storing Numbers for Easy Dialing .....	7-1
Storing One Touch Dial Numbers .....	7-1
Storing Speed Dial Numbers .....	7-2
Changing One Touch and Speed Dial Numbers.....	7-3
Setting Up Groups for Broadcasting .....	7-3
Dialing Options .....	7-4
Manual Dialing .....	7-4
One Touch Dialing .....	7-4
Speed Dialing .....	7-5
Dialing Access Codes and Credit Card Numbers.....	7-5
Search .....	7-6
Redial.....	7-6
Answering Calls with the Speaker Phone .....	7-6

Broadcasting .....	7-6
Pause .....	7-7
Hold .....	7-7
Tone/Pulse (For Canada Only) .....	7-7

## 8

<b>Telephone Services .....</b>	<b>8-1</b>
Custom Features .....	8-1
Distinctive Ring .....	8-1
What Does Your Telephone Company’s “Distinctive Ring” Do? .....	8-1
What Does Brother’s “Distinctive Ring” Do? .....	8-1
Do You Have Voice Mail?.....	8-2
Before You Choose the Ring Pattern to Register .....	8-2
VERY IMPORTANT .....	8-3
Registering the Distinctive Ring Pattern.....	8-3
Caller ID .....	8-3
Caller ID Log .....	8-3
Printing the Caller ID Log .....	8-4
Viewing the Caller ID Log.....	8-4
Returning a Call from the Log .....	8-4
Registering a Caller ID Number .....	8-5
Call Waiting Caller ID.....	8-6

## 9

<b>Message Center.....</b>	<b>9-1</b>
Message Center Mode .....	9-1
Flexible Memory Settings (Message Storage).....	9-1
Setting Up the Message Center .....	9-2
Setting Message Storage.....	9-2
Recording Message Center Outgoing Message.....	9-2
Listening to Outgoing Message (OGM) .....	9-3
Erasing Outgoing Message (OGM) .....	9-3
Activating Message Center Mode .....	9-3
Message Indicator.....	9-4
Playing Voice Messages .....	9-4
Printing a Fax Message .....	9-4
Backup Printing Option.....	9-5
Erasing Messages .....	9-5
To Erase Voice Messages Individually.....	9-5
To Erase Messages All at Once .....	9-5

Setting Maximum Time for Incoming Messages .....	9-6
Setting Toll Saver .....	9-6
ICM Recording Monitor .....	9-6
Recording a Conversation .....	9-7
Fax Forwarding/Paging .....	9-7
Programming a Fax Forwarding Number .....	9-7
Programming Paging Number .....	9-8
Remote Retrieval .....	9-9
Using Remote Access Code .....	9-9
Changing Remote Retrieval Access Code .....	9-9
Remote Commands .....	9-10
Retrieving Memory Status List .....	9-11
Retrieving Fax Messages .....	9-12
Changing Fax Forwarding Number .....	9-12

## 10

<b>Making Copies .....</b>	<b>10-1</b>
Copy Operations .....	10-1
Using the Fax Machine as a Copier .....	10-1
Making a Single Copy .....	10-1
Multiple Copies .....	10-2
Reducing and Enlarging Copies .....	10-2

## 11

<b>Printing Reports .....</b>	<b>11-1</b>
FAX Settings and Activity .....	11-1
Customizing the Transmission Verification Report .....	11-1
Setting the Fax Activity Report Interval .....	11-1
Using the Reports Key .....	11-2

## 12

<b>Important Information .....</b>	<b>12-1</b>
Standard Telephone and FCC Notices .....	12-1
International Energy Star Compliance Statement .....	12-2
Industry Canada Compliance Statement (For Canada Only) .....	12-2
Federal Communications Commission Compliance Notice (For USA Only) .....	12-2
Important Safety Instructions .....	12-3

<b>Troubleshooting and Routine Maintenance .....</b>	<b>13-1</b>
Troubleshooting.....	13-1
Error Messages .....	13-2
Clearing Jams .....	13-3
Replacing the Print Cartridge .....	13-5
If You Are Having Difficulty with Your Fax Machine.....	13-6
Printing or Receiving Faxes.....	13-6
Phone Line or Connections .....	13-7
Sending Faxes .....	13-7
Handling Incoming Calls .....	13-8
Routine Maintenance.....	13-9
Cleaning the Scanner .....	13-9
Cleaning the Print Head.....	13-9
Packing and Shipping the Fax Machine .....	13-10
 <b>Specifications .....</b>	 <b>S-1</b>
 <b>Index .....</b>	 <b>I-1</b>
Remote Retrieval Access Card.....	R-1

# 1 Introduction

## Using This Manual

---

Thank you for purchasing a Brother fax machine. This fax machine has been designed to be simple to use, with LCD screen prompts to guide you through functions. However, you can use your fax machine to its fullest potential by taking a few minutes to read this manual.



Additionally, your fax machine has a **Reports** Key. Press **Reports** to display HELP LIST, and then press **Menu/Set** to print a list of basic operational steps and explanations.

## Finding Information

All chapter headings and subheadings are listed in the Table of Contents. You will be able to find information about a specific feature or function by checking the Index at the back of this manual. Also, throughout this manual, you'll see special symbols alerting you to important information, cross-references, and warnings. Illustrations of some screen displays also help you choose the correct key-presses.

## Conventions Used in this Manual

Throughout this manual you'll see special symbols alerting you to important information, warnings, and actions to perform. For clarification, and to help you choose the correct key presses, we've added illustrations of some LCD messages.

<b>boldface</b>	Bold typeface identifies a specific key on the fax machine control panel.
<i>italics</i>	Italics typeface emphasizes an important point, or refer you to related topic.
bubble dot	Bubble Dot typeface identifies the messages on the LCD of the fax machine.



Warnings detail precautions you must take to avoid possible personal injury.



Cautions specify procedures you must follow or avoid to prevent possible damage to the fax machine.



Notes tell you the proper response for a situation that may occur.



FYI tips provide details about how the current operation interacts with other features.



Improper Setup alerts you to devices and procedures that are not compatible with the fax machine.

# FAX-885MC Control Panel Overview

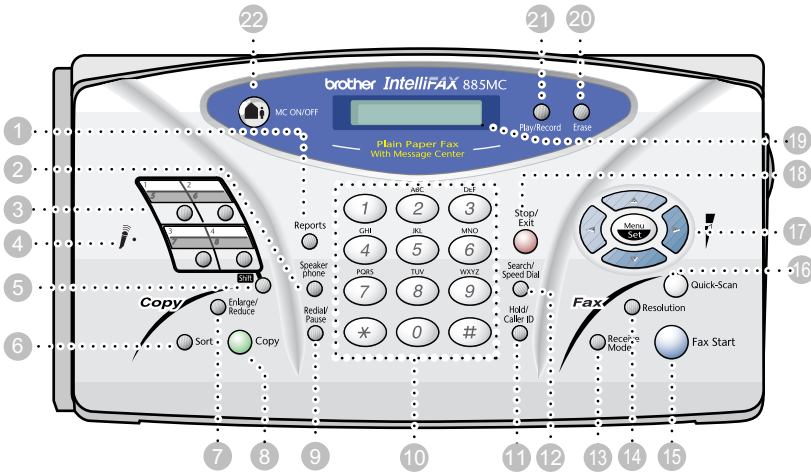

## 1 Reports

Access the Reports menu so you can select a report to print: Help List, Auto Dial, Fax Activity, Transmission User Settings and Memory Status List.

## 2 Speaker Phone

Lets you dial telephone and fax numbers without lifting the handset.

## 3 One Touch Dial Keys

These four keys give you instant access to eight previously stored phone numbers.

## 4 Microphone

Picks up your voice when you speak to another party using speakerphone.

## 5 Shift

This key is used to access the "5" through "8" One Touch numbers.

## 6 Sort

Use this key when you want multiple copies of a multiple page original in order.

## 7 Enlarge/Reduce

Use this key to enlarge or reduce copies depending on the ratio you select: 150%, 125%, 120%, 100%, 93%, 87%, 75% or 50%.

To reduce the image size automatically, select AUTO.

## 8 Copy

Makes a copy.

## 9 Redial/Pause

Re-dial the last number called. Also inserts a pause in autodial numbers.

## 10 Dial Pad

Dials phone and fax numbers, and can be used as a keyboard for entering information into the fax machine.

## 11 Hold/Caller ID

Lets you place calls on hold. Also, lets you view or print the Caller ID list.



**12 Search/Speed Dial**

Lets you dial stored phone numbers by pressing a two-digit number. Also, lets you look up numbers stored in the dialing memory.

**13 Receive Mode**

Use to select how fax machine will handle incoming calls.

**14 Resolution**

Sets the resolution when you send a fax or make a copy.

**15 Fax Start**

Starts an operation, such as sending a fax.

**16 Quick-Scan**

Lets you take advantage of memory transmission.

**17 Navigation Keys:**

**Menu/Set**

Lets you access the Menu and Programming mode and stores your settings in the fax machine.



Press to scroll forward or backward to set a menu selection.

Also, you can use these keys to do an alphabetical search for the names of stored numbers.



**Volume**

Press to scroll through the menus and options.

When using the speaker, ring or handset, you can press these keys to adjust the volume.

**18 Stop/Exit**

Stops a fax, cancels an operation or exits from Menu mode.

**19 Liquid Crystal Display (LCD)**

Displays messages to help you set up and operate your fax machine.

**20 Erase**

Lets you delete voice messages or all messages.

**21 Play/Record**

Lets you listen to voice messages and print fax messages stored in memory. Also, lets you record telephone calls.

**22 MC ON/OFF**

Lets you activate the Message Center. Also, notifies you that you have voice or fax messages in the memory.

# About Fax Machines

---

If you're a first-time fax machine user, fax operation might seem a little mysterious. You'll soon get used to the unusual fax tones on your phone line, and be able to send and receive faxes easily.

## Custom Features

### Do You Have Voice Mail on the Phone Line?

If you have Voice Mail on the phone line on which you will install your new fax machine, *there is a strong possibility that Voice Mail and the fax machine will conflict with each other while receiving incoming calls.*

### Why Should There Be Trouble?

Since both fax machines and Voice Mail pick up the line at the number of rings you have set, each of them has the ability to keep the other from receiving calls. For example, if your Voice Mail is set to answer after two rings and your fax machine is set to answer after four, your Voice Mail will keep your fax machine from receiving faxes. If you set Voice Mail and the Brother machine to answer at the same number of rings, there is no way of knowing which one will answer first. It is important to remember that neither Voice Mail nor the fax machine can pass the call back to the other after the call has been answered.

### How Can You Avoid Possible Problems?

A very good way to avoid problems like the one mentioned previously is *to get a second phone number on your present phone line.* Many people with Voice Mail opt for this choice, which is called “Distinctive Ring,” and they are very satisfied with it. *For details about this type of custom service, please see Distinctive Ring, page 8-1.*

Another way to avoid possible problems is to replace your Voice Mail with an answering machine. Your Brother fax machine is designed to work in tandem with an answering machine or TAD (telephone answering device). (See *Connecting an External Telephone Answering Device (TAD)*, page 2-9.)

## Fax Tones and Handshake

When someone is sending a fax, the fax machine sends fax calling tones (CNG tones)—soft, intermittent beeps at 4-second intervals. You'll hear them when you dial, and then press **Fax Start**, and they continue for about 60 seconds after dialing. During that time, the sending machine must begin the “handshake” with the receiving machine. Each time you use automatic procedures to send a fax, you are sending CNG tones over the phone line. You'll soon learn to listen for these soft beeps each time you answer a phone on your fax line, so you know if you are receiving a fax message.

The receiving fax responds with fax receiving tones—loud, chirping sounds. A receiving fax chirps for about 40 seconds over the phone line, and the LCD shows **RECEIVE**. If your fax machine is set to the **FAX ONLY Mode**, it will answer every call automatically with fax receiving tones. Even if the other party hangs up, your fax machine continues to send the “chirps” for about 40 seconds, and the LCD continues to display **RECEIVE**. To cancel the receiving mode, press **Stop/Exit**.

When your fax machine answers in **FAX/TEL Mode**, the fax machine listens for CNG tones and then responds with receiving tones.

The fax “handshake” is the time in which the sending machine’s CNG tones and the receiving machines “chirps” overlap. This must be for at least 2 to 4 seconds, so the machines can understand how each is sending and receiving the fax. The handshake cannot begin until the call is answered, and the CNG tones only last for about 60 seconds after the number is dialed. Therefore, it’s important for the receiving machine to answer the call in as few rings as possible.



When you have an external telephone answering device (TAD) on your fax line, your TAD will determine the number of rings before the call is answered. Pay special attention to the directions in the **Installation** chapter for connecting a TAD to your fax machine.

## **ECM (Error Correction Mode)**

The Error Correction Mode (ECM) is a way for the fax machine to check the integrity of a fax transmission while it is in progress. ECM transmissions are possible only between machines that both have the ECM feature. If they do, you may send and receive fax messages that are continuously checked for their integrity.

Sufficient memory must be available in your fax machine for this feature to work.

## **Test Sheet Procedure and Product Registration (For USA Only)**

After programming your Station ID, please fill out the **TEST SHEET** included with your fax machine, and then fax it to Brother’s Automated Fax Response System as your first transmission. This will verify that your fax machine is properly installed. To get a response, you must have set up your Station ID. (See *Setting Station ID*, page 4-1 in the Owner’s Manual.)

When your **TEST SHEET** is received, a Confirmation Sheet and Product Registration form will be sent back to your machine. Please fill out the form and return it to complete your registration.

**USA:** 1-908-685-9283 (fax)

# 2

## Location and Connections

### **Caution**

---

- Never install telephone wiring during a lightning storm.
- We recommend that this product be used with a surge protection device to protect the product against lightning storms.
- Never install a telephone jack in a wet location unless the jack is specifically designed for a wet location.
- Never touch telephone wires or terminals that are not insulated unless the telephone line has been disconnected at the network interface.
- Use caution when installing or modifying telephone lines.
- Avoid using a telephone (other than a cordless type) during an electrical storm. There may be a remote risk of electric shock from lightning.
- Do not use the telephone to report a gas leak in the vicinity of the leak.
- For PLUG CABLE EQUIPMENT, the socket-outlet should be installed near the equipment and should be easily accessible.

### **Choosing a Location**

---

Place your fax machine on a flat, stable surface, such as a desk. Select a place that is free of vibration and shocks. Locate the fax machine near a telephone jack and a standard, grounded power outlet.

- ⊘ Avoid placing your machine in a high-traffic area. Do not place near heaters, air conditioners, water, chemicals or refrigerators. Do not expose the fax machine to direct sunlight, excessive heat, moisture or dust. Do not connect your machine to electrical outlets controlled by wall switches or automatic timers. Disruption of power can wipe out information in the unit's memory. Do not connect your machine to electrical outlets on the same circuit as large appliances or other equipment that might disrupt the power supply. Avoid interference sources, such as speakers or the base units of cordless phones.

# Packing List

Make sure you have the following items:

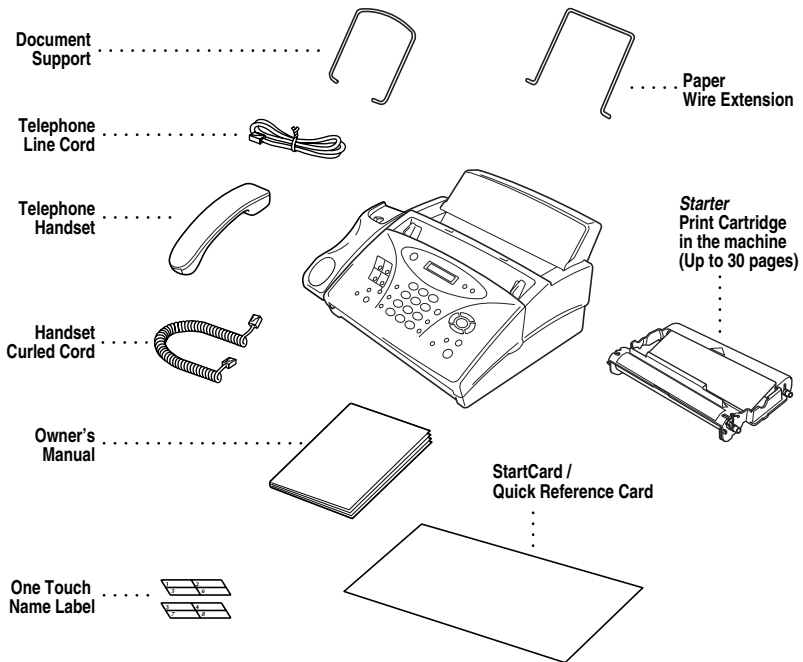

If an item is missing, call Brother Customer Service at 1-800-284-4329 (**in USA**), 1-800-853-6660 (**in Canada**) or 1-514-685-6464 (**in Montreal**). See Ordering Accessories and Supplies on page ii for the correct item numbers.



Whenever you transport the fax machine, use the packing materials that came with your machine. If you do not pack the fax machine correctly, you may void your warranty.

# Assembly

---

## Attach the Document Support

Insert the document support into the openings as shown in the illustration below.

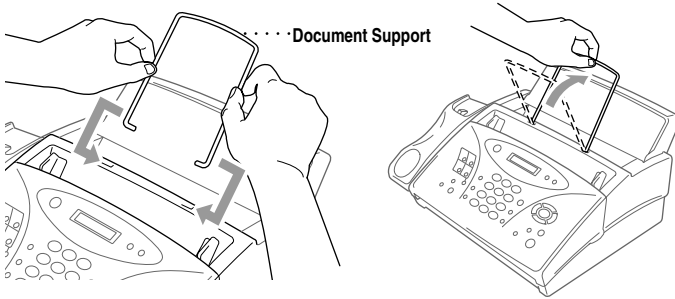

## Attach the Paper Wire Extension

Attach the paper wire extension.

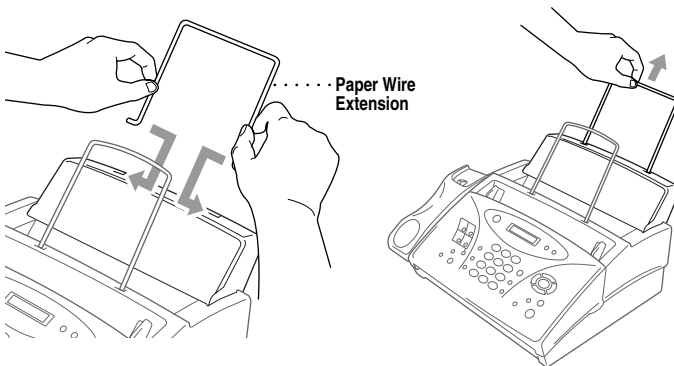

## Load the Paper

The paper cassette can hold about 100 sheets of 20-lb. paper.

- 1 Open the paper cover.
- 2 Place up to 100 sheets of paper in the paper holder. Do not allow the level of paper to pass the maximum paper line on the paper guides.
- 3 Close the paper cover.

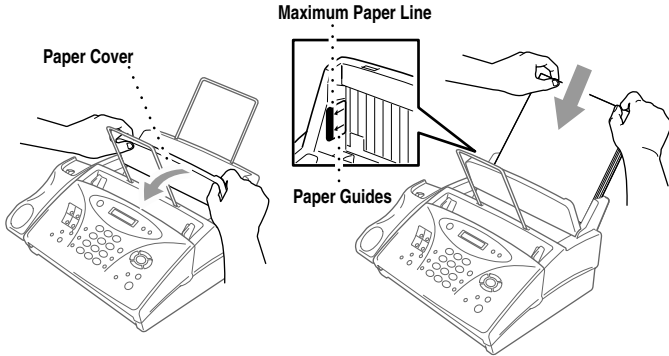

## Acceptable Paper

**Size:** Letter, Legal and A4

**Weight:** 17 lb. – 24 lb.

**Thickness:** .0031 inches – .0039 inches

- ⊘ **Do not** use curled, wrinkled, folded or ripped paper, or paper with staples, paper clips, paste or tape attached. **DO NOT** use cardboard, newspaper or fabric.

# Connections

---

## Connecting the Machine

Connect the handset, power cord and telephone line.

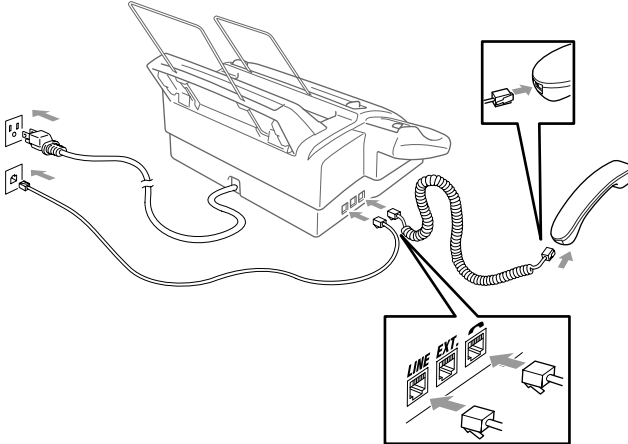

### 1 Connect the Handset.

Connect the curled handset cord to the bottom of the handset and to the left of the machine.

### 2 Connect the power cord.

### 3 Connect the telephone line.

Connect one end of the telephone line cord to the jack labeled **LINE** on the left of the machine. Connect the other end to a modular wall jack.

## WARNING

- This machine must be grounded using a three-prong plug.
- Since the machine is grounded through the power outlet, you can protect yourself from potentially hazardous electrical conditions on the telephone line by keeping the power to your machine on when you connect it to a telephone line. When you want to move your machine, protect yourself by disconnecting the telephone line first, and then the power cord.
- Lightning and power surges can damage this product! We recommend that you use a quality surge protection device on the AC power line as well as on the telephone line, or unplug the lines during a lightning storm.



## Special Line Considerations

### Roll Over Phone Lines

A roll over phone system is a group of two or more separate telephone lines that pass incoming calls to each other if they are busy. The calls are usually passed down or “rolled over” to the next available phone line in a preset order.

Your fax machine can work in a roll over system as long as it is the last number in the sequence, so the call cannot roll away. Do not put the fax machine on any of the other numbers; when the other lines are busy and a second fax call is received, the fax call is transferred to a line that does not have a fax machine. Your fax machine will work best on a dedicated line.

### Two-Line Phone System

A two-line phone system is nothing more than two separate phone numbers on the same wall outlet. The two phone numbers can be on separate jacks (RJ11) or combined into one jack (RJ14). Your machine must be plugged into an RJ11 jack. RJ11 and RJ14 jacks may be equal in size and appearance and both may contain four wires (black, red, green, yellow). To test the type of jack, plug in a two-line phone and see if it can access both lines. If it can, you must separate the line for your machine.

### Converting Telephone Wall Outlets

There are three ways to convert to an RJ11 receptacle. The first two ways may require assistance from the telephone company. You can change the wall outlets from one RJ14 jack to two RJ11 jacks. Or, you can have an RJ11 wall outlet installed and slave or jump one of the phone numbers to it.

The third way is the easiest: Buy a triplex adapter. You can plug a triplex adapter into an RJ14 outlet. It separates the wires into two separate RJ11 jacks (Line 1, Line 2) and a third RJ14 jack (Lines 1 and 2). If your Brother machine is on Line 1, plug the machine into L1 of the triplex adapter. If your machine is on Line 2, plug it into L2 of the triplex adapter.

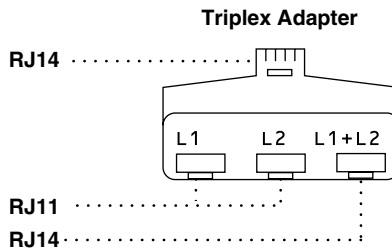

## Installing Brother Machine, External Two-Line TAD and Two-Line Telephone

When you are installing an **external** two-line telephone answering device (TAD) and a two-line telephone, your machine must be isolated on one line at both the wall jack and at the TAD. *The most common connection is to put the Brother machine on Line 2, which is our assumption in the following steps.* The back of the two-line TAD must have two telephone jacks: one labeled L1 or L1/L2, and the other labeled L2. You will need at least three telephone line cords, the one that came with your machine and two for your external two-line TAD. You will need a fourth line cord if you add a two-line telephone.

- 1 Place the two-line TAD and two-line telephone next to your Brother machine.
- 2 Plug one end of the telephone line cord for your machine into the L2 jack of the triplex adapter. Plug the other end into the **LINE** jack on the back of the machine.
- 3 Plug one end of the first telephone line cord for your TAD into the L1 jack of the triplex adapter. Plug the other end into the L1 or L1/L2 jack of the two-line TAD.
- 4 Plug one end of the second telephone line cord for your TAD into the L2 jack of the two-line TAD. Plug the other end into the **EXT.** jack on the back of the machine.

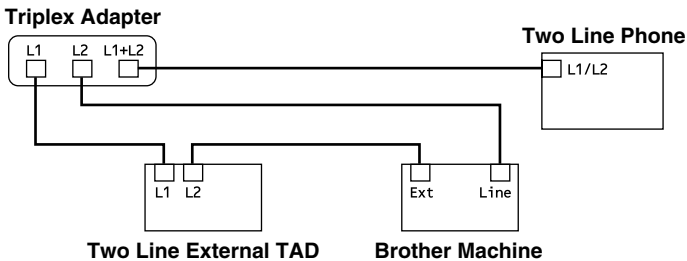

You can keep two-line telephones on other wall outlets as always. There are two ways to add a two-line telephone to the fax machine's wall outlet. You can plug the telephone line cord from the two-line telephone into the L1+L2 jack of the triplex adapter. Or, you can plug the two-line telephone into the TEL jack of the two-line TAD.

## Multi-Line Connections (PBX)

Most offices use a central telephone system. While it is often relatively simple to connect the fax machine to a key system or a PBX (Private Branch Exchange), we suggest that you contact the company that installed your telephone system and ask them to connect the fax machine for you. It is advisable to have a separate line for the fax machine. You can then leave the fax machine in FAX ONLY Mode to receive faxes any time of day or night.

If the fax machine is to be connected to a multi-line system, ask your installer to connect the unit to the last line on the system. This prevents the unit from being activated each time a telephone call is received. (See *Easy Receive*, page 5-4.)

⊘ As with all fax units, this machine must be connected to a two wire system. If your line has more than two wires, proper connection of the fax machine cannot be made.

### **If You Are Installing the Fax Machine to Work with a PBX:**

- 1** It is not guaranteed that the unit will operate correctly under all circumstances with a PBX. Any cases of difficulty should be reported first to the company that handles your PBX.
- 2** If all incoming calls will be answered by a switchboard operator, it is recommended that the Answer Mode be set to MANUAL. All incoming calls should initially be regarded as telephone calls.
- 3** The unit may be used with either pulse or tone dialing telephone service.

### **Custom Features on Your Phone Line**

If you have Voice Mail, Call Waiting, RingMaster, an answering service, or an alarm system custom feature on one phone line, it may create a problem with the operation of your fax machine. (See *Custom Features on a Single Line*, page 13-8.)

# Connecting an External Telephone Answering Device (TAD)

## Sequence

You might choose to connect an additional answering system. When you have an external TAD on the same telephone line as the fax machine, the TAD answers all calls. The fax machine “listens” for fax calling (CNG) tones. If it hears them, the fax machine takes over the call and receives the fax. If it doesn’t hear CNG tones, the fax machine lets the TAD continue playing your outgoing message so your caller can leave you a voice message.

The TAD must answer within four rings (the recommended setting is two rings). The fax machine cannot hear CNG tones until the TAD has answered the call, and with four rings there are only 8–10 seconds of CNG tones left for the fax “handshake.” Make sure you carefully follow instructions in this manual for recording your outgoing message. We do not recommend using the toll saver feature on your external answering machine if it exceeds 4 rings.

- ⊘ Do not connect a TAD elsewhere on the same phone line—your fax machine and TAD will both try to control the line.

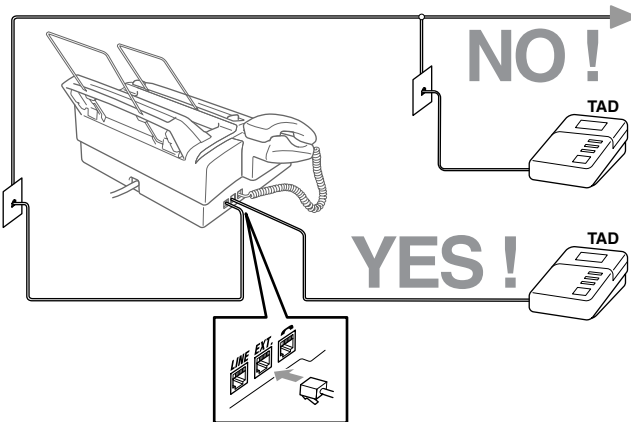

## Connections

The external TAD must be plugged into the left of the fax machine, into the jack labeled EXT. Your fax machine cannot work properly if you plug the TAD into a wall jack.

- 1 Plug the telephone line cord from the wall jack into the left side of the fax machine, in the jack labeled LINE.
- 2 Plug the telephone line cord from your TAD into the left side of the fax machine, in the jack labeled EXT. (Make sure this cord is connected to the TAD at the TAD's telephone line jack (not to telephone set jack).)
- 3 Set your external TAD to four rings or less. (The fax machine's Ring Delay setting does not apply.)
- 4 Record the outgoing message (see below).
- 5 Set the TAD to answer calls.
- 6 See Message Storage (**Menu/Set, 8, 1**) to **VOICE:EXT**.
- 7 Set the Receive Mode to **MC:MSG CTR**.

## Outgoing Message (OGM) on an External TAD

Timing is important in recording this message. The message sets up the ways to handle both manual and automatic fax reception.

- 1 Record 5 seconds of silence at the beginning of your message. (This allows your fax machine time to listen for the fax CNG tones of automatic transmissions before they stop.)
- 2 Limit your speaking to 20 seconds.
- 3 End your 20-second message by giving your Fax Receive Code for people sending manual faxes. For example:  
"After the beep, leave a message or send a fax by pressing ✖ 5 1 and Start."

## Connecting an External Telephone

Your fax machine is equipped with a handset that you can use as a regular phone. However, you can also connect a separate telephone (or telephone answering device) directly to your fax machine.

Connect the modular plug on the telephone's line cord to the jack labeled EXT. on the left side of the fax machine.

Whenever this phone (or TAD) is in use, the LCD shows **EXT. TEL IN USE**, and, if the fax machine handset is lifted, an alarm sounds. To disconnect the call and switch to the fax machine, press **Speaker Phone**.

# 3 On-Screen Programming

## User-Friendly Programming

We have designed your fax machine with on-screen programming using navigation keys. User-friendly programming helps you take full advantage of all the menu selections your fax machine has to offer.

Since your programming is done on the LCD, we created step-by-step on-screen prompts to help you program your fax machine. All you need to do is follow the prompts as they guide you through the menu selections and programming options. Additionally, you can program settings more quickly by pressing **Menu/Set** and the menu number using the dial pad.

### Menu Selection Table

You can probably perform most of these programming operations without the Owner's Manual. To help you understand the menu selections and options that are found in the FAX programs, use the Menu Selection Table on page 3-3.

You can also program your fax machine by pressing **Menu/Set** followed by the menu number. For example: to set **VOLUME AMPLIFY** to **ON**, press

**Menu/Set**, **1**, **4** and  to select **ON**, and then press **Menu/Set**.





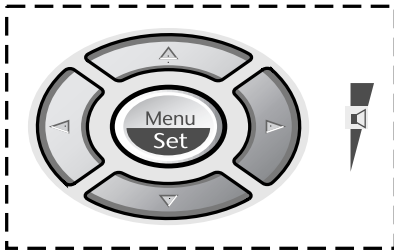

### Alternating Displays

Sometimes, the LCD alternates between the active setting and a help message giving brief instructions about how to proceed. The display you'll probably see most often is shown below. When you place an original in the ADF, it appears to tell you that you can dial a number and send a fax, or you can make a copy.



# Navigation Keys



-  \* Access the Menu
-  \* Go to next menu level
-  \* Accept an option
-  \* Scroll through the current menu level
-  \* Back to previous menu level
-  \* Forward to next menu level
-  \* Exit the Menu





You can access the menu mode by pressing **Menu/Set**. When you enter the Menu, the LCD scrolls:

SELECT ↑ ↓ & SET

Then press **1** for Initial Setup Menu—**OR**—  
 Press **2** for Setup Receive Menu—**OR**—  
 Press **3** for Setup Send Menu—**OR**—  
 Press **4** for Cancel Job  
 ⋮

1. INITIAL SETUP  
 2. SETUP RECEIVE  
 3. SETUP SEND  
 4. CANCEL JOB

—**OR**—

You can scroll more quickly through the each menu level by pressing  **OR** , and then set an option by pressing **Menu/Set** when that option appears on the LCD. Then the LCD shows next menu level. Press  **OR**  to scroll to your next menu selection, and then press **Menu/Set**.

When you finish setting an option, the LCD shows **ACCEPTED**.



Use  to scroll backward if you passed your choices or to save keystrokes.

To access the menu, press  **Menu/Set**.

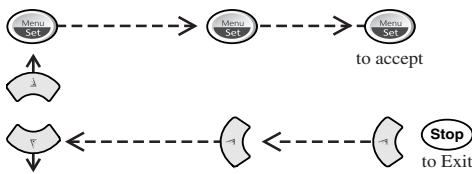

Main Menu	Menu Selections	Options	Descriptions	Page	
<b>1. INITIAL SETUP</b>	<b>1. DATE/TIME</b>	—	Enter date and time for the LCD display and heading on fax transmissions.	4-1	
	<b>2. STATION ID</b>	—	Program your name, fax number and telephone number to appear on each transmitted page.	4-1	
	<b>3. BEEPER</b>	OFF HIGH LOW	↑ ↔ ↓	Adjusts beeper volume.	4-5
	<b>4. VOLUME AMPLIFY</b>	ON (PERMANENT/ TEMPORARY)  OFF	↔ ↔ ↑ ↔ ↓	For the hearing-impaired, you can set the volume to the VOL AMPLIFY:ON setting on a permanent or temporary basis.	4-5
	<b>5. TONE/PULSE (For Canada Only)</b>	TONE  PULSE	↑ ↔ ↓	Selects dialing mode	4-6
	<b>6. LOCAL LANGUAGE (For Canada Only)</b>	ENGLISH  FRENCH	↑ ↔ ↓	Allows you to change the LCD Language to French.	See French manual
<b>2. SETUP RECEIVE</b>	<b>1. RING DELAY</b>	<b>04</b> 03 02 01 00	Number of rings before the fax machine answers in FAX/TEL, FAX or TAD mode.	5-2	
	<b>2. F/T RING TIME</b>	70 40 30 20	Sets the time for “double-ring” in FAX/TEL mode.	5-3	
	<b>0. EASY RECEIVE</b>	ON  SEMI  OFF	↑ ↔ ↓	Receive fax messages without pressing the Fax Start key.	5-4



The factory setting (option) is shown in bold.



To access the menu, press  **Menu/Set**.

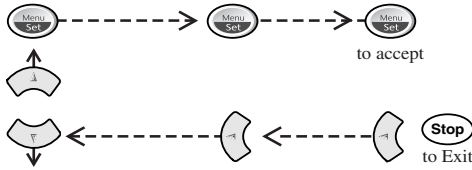

Main Menu	Menu Selections	Options	Descriptions	Page
<b>2. SETUP RECEIVE (Continued)</b>	<b>4. REMOTE CODE</b>	<b>ON</b> (*51, #51)  OFF	Activate or deactivate the fax machine from a remote location. You can also personalize these codes.	5-6
	<b>5. REDUCTION</b>	<b>AUTO</b> 100% 93% 87% 75%	Reduces size of image.	5-4
	<b>6. PAPER</b>	<b>LETTER</b>  LEGAL  A4	Selects size of paper for fax receiving	5-5
	<b>7. POLLING RX</b>	<b>ON</b>  <b>OFF</b>	Sets up your fax machine to poll another fax machine.	5-7
<b>3. SETUP SEND</b>	<b>1. COVERPG SETUP</b>	<b>NEXT FAX ONLY.</b> <b>ON</b> <b>OFF</b> PRINT SAMPLE	Automatically sends a cover page you program.	6-6
	<b>2. COVERPAGE MSG</b>	—	Programs customized message for fax cover page.	6-6
	<b>3. CONTRAST</b>	<b>AUTO</b>  S.LIGHT  S.DARK	Changes lightness or darkness of a fax you are sending.	6-3
	<b>4. RESOLUTION</b>	<b>STANDARD</b> FINE S.FINE PHOTO	Changes the fax resolution.	6-3
	<b>5. OVERSEAS MODE</b>	<b>ON</b>  <b>OFF</b>	Adjusts for sometimes difficult overseas transmissions.	6-4
	<b>6. CALL RESERVE</b>	<b>OFF</b>  ON  PRINT SAMPLE	You can send a fax, then speak.	6-6



The factory setting (option) is shown in bold.

To access the menu, press  **Menu/Set**.

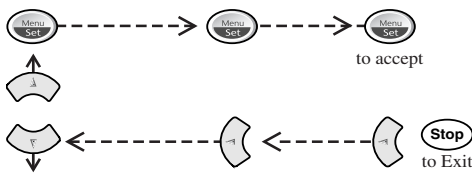

Main Menu	Menu Selections	Options	Descriptions	Page
3. SETUP SEND (Continued)	7. DELAYED FAX	—	Sends documents later	6-4
	8. POLLED TX	ON <b>OFF</b>	Sets up your fax machine with a document to be retrieved by another fax machine.	6-5
4. CANCEL JOB	—	—	Cancel a delayed fax or polling job.	6-5
5. INTERRUPT	—	—	Send a fax now, even if you have the machine set to send a fax later, or if you have it set for polling.	6-5
6. SET AUTO DIAL	1. ONE-TOUCH DIAL	—	Stores dial numbers in memory so as to dial them by pressing only one key.	7-1
	2. SPEED-DIAL	—	Stores dial numbers in memory so as to dial them by pressing four keys.	7-2
	3. SETUP GROUPS	—	Sets up a Group number for Broadcasting.	7-3
7. SETUP REPORTS	1. TRANSMISSION	ON <b>OFF</b>	Print lists and reports of activity. (See details in Chapter 11.)	11-1
	2. ACT.INTERVAL	<b>OFF</b> 6/12/24 Hours 2/4/7 Days		11-1



The factory setting (option) is shown in bold.

To access the menu, press  **Menu/Set**.

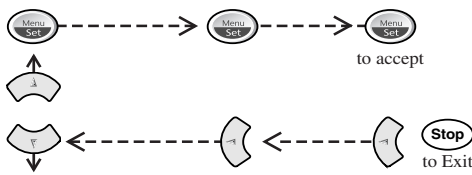

Main Menu	Menu Selections	Options	Descriptions	Page
<b>8. SETUP MSG CTR</b>	<b>1. MSG STORAGE</b>	FAX: <b>ON/OFF</b> VOICE: <b>ON/EXT/OFF</b>	Select if memory will store fax, voice or both.	9-2
	<b>0. BACKUP PRINT</b>	<b>ON</b>  <b>OFF</b>	Prints copy of faxes received into memory.	9-5
	<b>0. OGM</b>	<b>MSG CTR OGM</b> F/T OGM	Select/Record outgoing message.	9-2
	<b>0. ICM MAX. TIME</b>		Select maximum length of incoming messages.	9-6
	<b>0. ICM REC. MONITR</b>	<b>ON</b>  <b>OFF</b>	Adjust speaker volume for voice messages as they come in.	9-6
	<b>0. FAX FWD/PAGING</b>	<b>OFF</b>  FAX FORWARD PAGING	Set FAX to forward fax message – <b>OR</b> – to call your pager.	9-7
	<b>0. REMOTE ACCESS</b>	<b>159 *</b>	Set code for retrieving messages.	9-9
<b>0. TEL SERVICE</b>	<b>1. DISTINCTIVE</b>	<b>ON</b>  <b>OFF</b>  <b>SET</b>	Use with telephone company Distinctive Ring service to register the ring pattern with fax machine.	8-3
	<b>2. CALLER ID (For USA Only)</b>	—	Register your AREA CODE to dial from the Caller ID log.	4-6 8-4



The factory setting (option) is shown in bold.

# 4 Initial Setup

## Getting Started





---

After you have assembled your machine using the Brother StartCard, continue the initial setup by programming the rest of the initial settings.

### Setting Date and Time

Your fax machine displays the date and time, and prints it on every fax you send.

In the event of a power failure, the fax machine maintains date and time information for up to two hours. All other settings remain unaffected.



- 1 Press **Menu/Set**, 1, 1. 
- 2 Enter the last two digits of the year, and then press **Menu/Set**.   

- 3 Enter two digits for the month, and then press **Menu/Set**. (For example, enter 09 for September, or 10 for October)
- 4 Enter two digits for the day, and then press **Menu/Set**. (For example, 06) 
- 5 Enter the time in 24-hour format, and then press **Menu/Set**. (For example, enter 15:25 for 3:25 PM) 
- 6 Press **Stop/Exit**. The LCD now shows the date and time you set and displays it whenever the fax machine is in Standby mode.

### Setting Station ID

You can store your name, fax number, and telephone number to be printed on all fax pages.

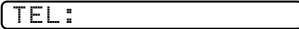

The telephone number you enter will be printed on Call Back Message and Cover Page you send.

- 1 Press **Menu/Set**, 1, 2. 
- 2 Enter your fax number (up to 20 digits), and then press **Menu/Set**. 
- 3 Enter your telephone number (up to 20 digits), and then press **Menu/Set**. If your telephone number and fax number are the same, enter the same number again. The LCD shows your entry. 

- 4 Use the dial pad to enter your name (up to 20 characters), and then press **Menu/Set**. (You can use the chart on next page to help you enter letters.)
- 5 Press **Stop/Exit**. The LCD returns to the date and time.

NAME :

## NOTICE

The Telephone Consumer Protection Act of 1991 makes it unlawful for any person to use a computer or electronic device to send any message via a telephone fax machine unless such messages clearly contain, in a margin at the top or bottom of each transmitted page, or on the first page of the transmission, the date and time it is sent and an identification of the business or other entity or other individual sending the message and the telephone number of the sending machines or such business, other entity or individual.

In order to program this information into your fax machine, you should complete the steps described on page 4-1.

### Details for Entering Text

When you are setting certain functions, such as the Station ID, you may need to enter text into the fax machine. Most keys on the dial pad have three or four letters printed above them. The keys for 0, # and \* don't have printed letters because they are used for special characters or operations.

By pressing the appropriate number on the dial pad the correct number of times, you can access the character you want.

Press Key	one time	two times	three times	four times
<b>2</b>	A	B	C	2
<b>3</b>	D	E	F	3
<b>4</b>	G	H	I	4
<b>5</b>	J	K	L	5
<b>6</b>	M	N	O	6
<b>7</b>	P	Q	R	S
<b>8</b>	T	U	V	8
<b>9</b>	W	X	Y	Z

### Inserting Spaces

If you want to enter a blank space, press  twice.

## Making Corrections

If you entered a letter incorrectly and want to change it, press  to move the cursor after the last correct letter. Then press **Stop/Exit**; the letters above and to the right of the cursor are deleted. Re-enter the correct text and/or digits. You can also back up and type over incorrect letters.

## Repeating Letters

If you need to enter a character that is assigned to the same key as the previous character, press  to move the cursor to the right.

## Special Characters and Symbols

Press **\***, **#** or **0** repeatedly or press  to move the cursor under the special character or symbol you want. Then press **Menu/Set** to select it.

Press **\*** for (space) ! " # \$ % & ' ( ) \* + , - . /

Press **#** for : ; < = > ? @ [ ] ^ \_

Press **0** for É À È Ê Î Ç Ë Ö 0



- If you do not enter a fax number, no additional information can be entered.
- To enter a space, press  once between numbers and twice between characters.
- If your Station ID has already been programmed, the screen prompts “1” to make a change, or “2” to exit without changing.

## Setting the Speaker Volume

You can adjust the speaker volume by pressing **Speaker Phone**, and then selecting a speaker volume level.

Press  to adjust the volume level. The LCD shows the setting you are choosing.

Each key press changes the volume to the next setting. The new setting will remain until you change it again.



You can adjust the speaker volume while you are listening to your OGM (Outgoing Message) and ICMs (Incoming Messages).



If you turn Incoming Recording Monitor to OFF (**Menu/Set, 8, 5**) the Speaker for screening calls will be disabled and you won't hear callers leaving messages. The

volume for other operations can still be controlled using .

## Choosing the Handset Volume (For Volume Amplify)

Before you begin to use the machine, you must decide if you need to set the handset volume to **AMPLIFY:ON** for a user who is hearing-impaired. The AMPLIFY volume level complies with FCC standards.

### *VOLUME AMPLIFY: OFF*

This default setting is appropriate if *none* of the users are hearing-impaired. During a conversation, users can press Volume  on the control panel to adjust the volume to **LOW** or **HIGH**. When the handset is replaced, the handset volume will remain until you change it again.

### *VOLUME AMPLIFY: ON-TEMPORARY*

This setting is appropriate if *some* of the users are hearing-impaired. During a conversation, users can press Volume  on the control panel to adjust the volume to **LOW**, **HIGH** or **AMPLIFY**. When the handset is replaced, the handset volume returns to the default setting of **LOW**.

### *VOLUME AMPLIFY: ON-PERMANENT*

Choose **VOL AMPLIFY:ON-PERMANENT** if *all* of the users are hearing-impaired. During a conversation, users can press Volume  on the control panel to adjust the volume to **LOW**, **HIGH** or **AMPLIFY**. When the handset is replaced, the handset volume returns to the default setting of **AMPLIFY**.



When you press Volume  on the control panel to adjust the volume, the LCD shows the setting you are choosing. Each key press changes the volume to the next setting.





## WARNING

It is important that you do not choose **PERMANENT** unless all users are **hearing-impaired**. Otherwise, the default setting of **AMPLIFY** may damage the hearing of some users.

## Setting Volume Amplify

Please carefully read *Setting the Handset Volume* before you do the following steps:

- 1 Press **Menu/Set**, **1**, **4**. 4.VOLUME AMPLIFY
- 2 Press  to select **VOL AMPLIFY:OFF?** if VOL AMPLIFY:OFF?  
none of the users are hearing-impaired and go to Step 4—**OR**—If some or all of the users are hearing-impaired, select **VOL AMPLIFY:ON?** and then press **Menu/Set**.
- 3 Press  to select **PERMANENT?** if all the users PERMANENT?  
are hearing-impaired—**OR**—Select **TEMPORARY?** if only some of the users are hearing-impaired.
- 4 Press **Menu/Set**.
- 5 Press **Stop/Exit**.

## Setting the Ring Volume

You can adjust the ring volume when your fax machine is idle. You can select a ring volume level or press until the ring is off.

Press  to adjust the volume level. With each key press, the fax machine rings so you can hear the current setting and the LCD shows the setting you are choosing. Each key press changes the volume to the next setting. The new setting will remain until you change it again.

## Setting Beeper Volume

You can set the beeper to **LOW**, **HIGH** or **OFF**. The default setting is **LOW**. When the beeper is set to **LOW** or **HIGH**, the fax machine beeps every time you press a key or make an error, and at the end of fax sending or receiving.

- 1 Press **Menu/Set**, **1**, **3**. 3.BEEPER
- 2 Press  to select your setting, and then press **Menu/Set**.
- 3 Press **Stop/Exit**.



## Memory Storage

In the event of a power failure, all settings in the **INITIAL SETUP**, **SETUP RECEIVE** and **SET AUTO DIAL** plus the **COVERPG SETUP** and **COVERPAGE MSG** (from **SETUP SEND**) functions are stored permanently. You may have to reset the date and time.

## Setting Tone/Pulse Dialing Mode (For Canada Only)

Your fax machine comes set to accommodate tone (multi-frequency) dialing service. If you have pulse (rotary) dialing service, you need to change the dialing mode.

- 1 Press **Menu/Set**, **1**, **5**.
- 2 Press  to select **TONE** or **PULSE**,  
and then press **Menu/Set**.
- 3 Press **Stop/Exit**.

## Setting Up Your Area Code (For USA Only)

You must set up your area code in Caller ID.

- 1 Press **Menu/Set**, **0**, **2**.
- 2 Use the dial pad to enter your area code,  
and then press **Menu/Set**.
- 3 Press **Stop/Exit**.

# 5 Setup Receive

## Basic Receiving Operations

### Select Receive Mode

**MANUAL**—You must answer all calls yourself. If you hear fax tones, press **Fax Start** to begin receiving the fax, then hang up. You can use this mode with Distinctive Ringing. (See *Distinctive Ring*, page 8-1.)

**FAX ONLY**—The fax machine automatically answers every call as a fax call. You cannot receive a voice call, but you can dial out and make a voice call.

**FAX/TEL**—The fax machine automatically answers every call. If the call is a fax, it prints the fax. If the call is not a fax, it signals you with a double-ring (ring-ring), different from the phone company ringing, to alert you to pick up the call. If you select this setting, you'll need to set the Ring Delay and F/T Ring Time features (on the following pages). If you have extension phones on the same line as the fax machine, set Ring Delay to 4. (See *For FAX/TEL Mode Only*, page 5-6.)

**MSG CTR**—The fax machine has a built-in digital Message Center for fax and voice. When you set the machine to answer calls, it will record messages up to 15 minutes. For more information about the Message Center (MSG CTR) operation, please see Chapter 9.

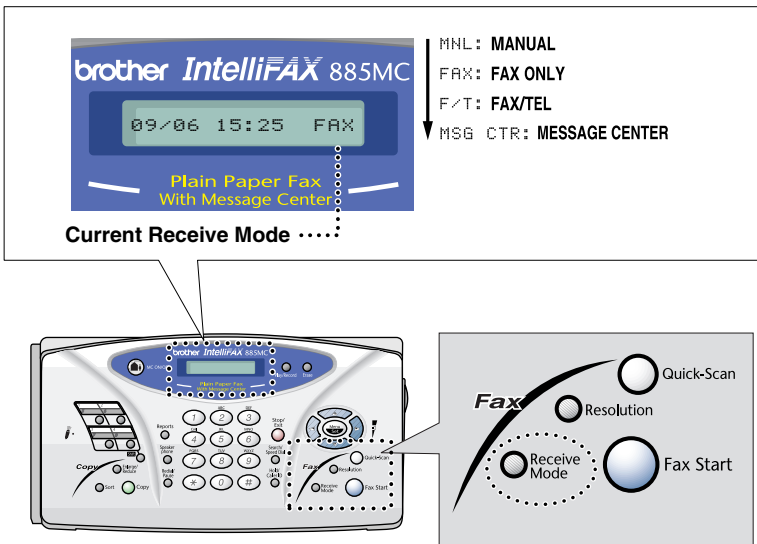

To select or change your Receive Mode

- 1 Press **Receive Mode**. The LCD shows your current selection.

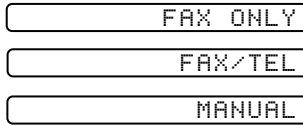

Or, if Message Center Mode is ON, it overrides your Receive Mode setting, so the LCD shows:



- 2 Continue to press **Receive Mode** until your new selection appears. After two seconds, the LCD returns to the date and time, along with your new Receive Mode setting.



If you're changing the Receive Mode while in another operation, the LCD returns to the current operation.

## Setting Ring Delay

The Ring Delay setting determines the number of times the fax machine rings before it answers. If you have extension phones on the same line as the fax machine, keep the Ring Delay default setting of **4**. (See *Easy Receive*, page 5-4, *Operation from External or Extension Telephone*, page 5-6 and *For FAX/TEL Mode Only*, page 5-6.)

- 1 Press **Menu/Set**, **2**, **1**.

The image shows a rectangular LCD display box containing the text "1. RING DELAY".

- 2 Press  to select how many times the line rings before the fax machine answers (00 – 04), and then press **Menu/Set**. If you select 00, the line doesn't ring at all.

- 3 Press **Stop/Exit**.

## Setting F/T Ring Time

You need to determine how long the fax machine will notify you with its special double-ring when you have a voice call. This ringing happens after the initial ringing from the phone company. Only the fax machine rings, for 20, 30, 40 or 70 seconds; no other phones on the same line ring the special double-ring. However, you can answer the call on any phone on the same line as the fax machine.

- 1 Press **Menu/Set, 2, 2.**

2.F/T RING TIME

- 2 Press  to select how long the fax machine will

RING TIME: 20 SEC

ring to alert you that you have a voice call, and then press **Menu/Set.**

- 3 Press **Stop/Exit.**

Now, when a call comes in and the machine is set to FAX/TEL mode, all phones on this line will ring the number of times you selected in Ring Delay.

You can let the fax machine pick up and detect if it's a fax or voice call. If it's a fax call, the machine prints the fax. If it's a voice call, the machine signals you with a double-ring for the length of time you selected in F/T Ring Time.



Even if the caller hangs up during the double-ringing, the fax machine continues for the set time.

## Record FAX/TEL Outgoing Message (F/T OGM)

This is the announcement played by your FAX (not an external TAD) when someone calls and your machine is set to FAX/TEL mode. *Although callers hear your announcement, they cannot leave a message.* To erase the announcement, follow the directions on *Erasing Outgoing Message (OGM)*, page 9-3.

- 1 Press **Menu/Set, 8, 3.** The screen prompts you to choose F/T OGM or MSG CTR OGM.

- 2 Press  to select **F/T OGM** (not MSG CTR OGM), and then press **Menu/Set.**

- 3 Press  to select **RECORD OGM?**, and then press **Menu/Set.**

Then pick up the handset to record a message.

- 4 Replace the handset. Your OGM is played.

- 5 Press **Stop/Exit.**

## Easy Receive

When you use this feature, you don't have to press **Fax Start** when you answer a fax call and hear calling beeps. Just hold the handset and wait a few seconds. When you see **RECEIVE** on the LCD or when you hear "chirps" through the handset of an extension phone connected to another wall jack, just replace the handset and your machine does the rest. Selecting **ON** allows the fax machine to receive fax calls automatically, even if you lift the handset of an extension or external phone. Selecting **SEMI** lets the machine receive the call only if you've answered it at the fax machine. Selecting **OFF** means you'll have to activate the fax machine yourself, by pressing **Fax Start** or by pressing **\* 5 1** if you are not at your machine. (See *Operation from External or Extension Telephone* and *For FAX/TEL Mode Only*, page 5-6.)

If you've set the feature to **ON**, but your fax machine doesn't automatically connect a fax call when you lift an external or extension phone handset, press the Fax Receive code **\* 5 1**. At the fax machine lift the handset, and then press **Fax Start**.

- 1 Press **Menu/Set**, **2**, **3**.

3.EASY RECEIVE

- 2 Press  to select **ON**, **SEMI** or **OFF**, and then press **Menu/Set**.

- 3 Press **Stop/Exit**.

## Printing a Reduced Incoming Original

You can always reduce the size of an incoming fax to a fixed percentage, regardless of the size of the paper (up to legal) in your fax machine. If you choose **AUTO**, your machine chooses the level of reduction for you.

- 1 Press **Menu/Set**, **2**, **5**.

5.REDUCTION

- 2 Press  to select the reduction ratio you want (**AUTO**, **100%**, **93%**, **87%** or **75%**), and then press **Menu/Set**. Choose 100% if you don't want a reduction.

- 3 Press **Stop/Exit**.

## Recommended Reductions

If your paper is letter size (8.5" × 11"), and the incoming fax is  
letter size, select 93%  
A4, select 87%  
legal size, select 75%.

If your paper is A4 (8.2" × 11.6"), and the incoming fax is  
letter size, select 100%  
A4, select 93%

If your paper is legal size (8.5" × 14"), and the incoming fax is  
letter size, select 100%  
A4, select 100%  
legal size, select 93%.

## Setting Paper Size

You can use three sizes of paper for printing your faxes—letter, legal and A4. When you change the kind of paper in the paper cassette, you will need to change the setting for paper size, so your machine will know how to fit the incoming fax on the page. You can also select the level of page reduction to fit the paper in your machine.

1 Press **Menu/Set**, **2**, **6**.



6.PAPER

2 Press  **OR**  to select **LETTER**, **LEGAL** or **A4**, and then press **Menu/Set**.

3 Press **1** if you want to change the reduction setting—**OR**—Press **2** to go to Step 5.

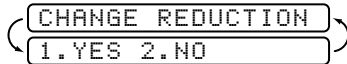

CHANGE REDUCTION  
1.YES 2.NO

4 Press  **OR**  to select **AUTO**, **100%**, **93%**, **87%** or **75%**, and then press **Menu/Set**.

5 Press **Stop/Exit**.

# Advanced Receiving Operations

## Operation from External or Extension Telephone

If you answer a fax call on an extension phone or on an external phone in the EXT. jack, you can make your fax machine take over by using the Fax Receive Code. When you press the Fax Receive Code **✖ 5 1**, the fax machine starts to receive a fax. (See *Easy Receive*, page 5-4.)

If the fax machine answers a voice call and double-rings for you to take over, use the Telephone Answer Code **# 5 1** to take the call at an extension phone. (See *Setting F/T Ring Time*, page 5-3.)

If you answer a call, and no one is on the line, assume you're receiving a fax. At the fax machine phone, press **Fax Start**, then hang up. At an extension phone, press **✖ 5 1**, wait for fax receiving tones (chirps), then hang up. At an external phone, press **✖ 5 1** and wait for the phone to be disconnected (the LCD shows **RECEIVE**) before you hang up. (Your caller will have to press **Fax Start** to send the fax.)

### For FAX/TEL Mode Only

When the fax machine is in FAX/TEL mode, it will use the F/T Ring Time (double-ringing) to alert you to a voice call. If you're at the fax machine, you can lift the handset to answer.

If you're at an extension phone, you'll need to lift the handset during the F/T Ring Time, and then press **# 5 1** between the double-rings. If no one is on the line, or if someone wants to send you a fax, send the call back to the fax machine by pressing **✖ 5 1**.

### Changing Remote Codes

Remote Codes might not work with some telephone systems. The preset Fax Receive Code is **✖ 5 1**. The preset Telephone Answer Code is **# 5 1**.



If you are always disconnected when accessing your external TAD remotely, try changing the Fax Receive Code from **✖ 5 1** to **###** and the Telephone Answer Code from **# 5 1** to **999**.

### To Change Remote Codes

- 1 Press **Menu/Set**, **2**, **4**.

4.REMOTE CODE

- 2 Press  to select **ON** (or **OFF**), and then press **Menu/Set**.

- 3 If you want to, enter a new Fax Receive Code, and then press **Menu/Set**.

FAX RECEIVE:\*51

- 4 If you want to, enter a new Telephone Answer Code, and then press **Menu/Set**.

TEL ANSWER:#51

- 5 Press **Stop/Exit**.

## Polling



Polling is the process of retrieving faxes from another fax machine. You can use your fax machine to “poll” other machines, or you can have someone poll your machine. All parties involved in polling need to set up their fax machines to accommodate polling. When someone polls your machine to receive a fax, they pay for the call; if you poll someone’s fax machine to receive a fax, you pay for the call.

(See *Canceling a Scheduled Job*, page 6-5.)

For details about the Polling feature, call our Brother fax-back system 1-800-521-2846 (**in USA**), 1-800-681-9838 (**in Canada**) and request the Index. (See *Features That Are Not in the Manual*, page 6-6 for details.)



Some fax machines do not respond to the Polling feature.



# 6 Setup Send

## Automatic Document Feeder (ADF)

---

- Originals must be between 5.8 and 8.5 inches wide and between 5.9 and 23.7 inches long. Your fax machine can scan an image only 8.2 inches wide, regardless of the paper width.
- Make sure you place the original **face down, top edge first**.
- Adjust the paper guides to fit the width of your original.

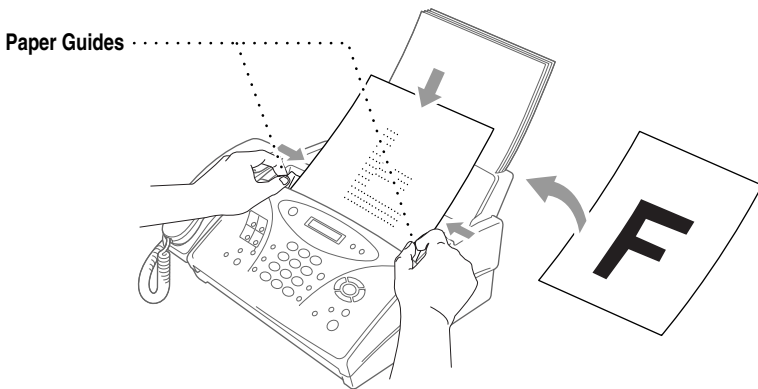

- The automatic document feeder (ADF) can hold up to 10 pages, feeding each one individually through the fax machine. Use standard (17 lb–24 lb) paper when using the ADF; if you're using heavier paper, feed each sheet individually to prevent paper jams.
- ⊘ **DO NOT** use curled, wrinkled, folded or ripped paper, or paper with staples, paper clips, paste or tape attached. **DO NOT** use cardboard, newspaper or fabric.
- Make sure originals written with ink are completely dry.
- 🔍 You must press **Resolution** (before you send the fax) to select the resolution for the type of original you're sending. (See *Resolution*, page 6-3.)

## Manual Transmission

Manual transmission lets you hear the dial tone, ringing and fax receiving tones before sending the fax.

- 1 Place the original face down in the ADF.
- 2 Pick up the handset and listen for a dial tone  
—OR—press **Speaker Phone** and listen for a dial tone.
- 3 Enter the fax number you want to call. (You can enter the digits using the dial pad, or you can enter a One Touch or Speed Dial number, or you can call using **Search/Speed Dial**.) (See *One Touch Dialing*, page 7-4 and *Search*, page 7-6.)
- 4 When you hear the fax tone, press **Fax Start**.
- 5 If you're using the handset, hang up.

## Automatic Transmission

This is the easiest way to send a fax.

**IMPORTANT:** Do **not** pick up the handset, or press **Speaker Phone**.

- 1 Place the original face down in the ADF.
- 2 Enter the fax number using One Touch, Speed Dial, Search or the dial pad. (See *One Touch Dialing*, *Speed Dialing* and *Search*, pages 7-4 to 7-6.)
- 3 Press **Fax Start**.

## Manual and Automatic Fax Redial

*If you're sending a fax manually* and the line is busy, press **Redial/Pause** to try again. Anytime you want to make a second call to the last number dialed, press **Redial/Pause** to save time.

*If you're sending a fax automatically* and the line is busy, the fax machine will redial automatically up to three times at 5 minute intervals.

## Quick Scan Fax Transmission

---

You can scan a fax into the fax machine's memory to be sent as soon as the scan is complete. This way, you don't have to wait for the entire fax to be transmitted before you retrieve your original.

If you get an **OUT OF MEMORY** message while scanning the first page of a fax, press **Stop/Exit** to cancel the scan. If you get an **OUT OF MEMORY** message while scanning in a subsequent page, you'll have the option to press **Fax Start** to transmit the pages scanned so far, or to press **Stop/Exit** to cancel the Quick Scan operation.



- 1 Place the original face down in the ADF.
- 2 Press **Quick-Scan**. The LCD indicates how much memory is available.
- 3 Enter the fax number.
- 4 Press **Fax Start** to begin scanning the document into memory. Once the scan is complete, the fax machine dials the call.

## Basic Sending Operations

---

### Contrast

If your original is very light or very dark, you might want to set the contrast accordingly. Use **S.LIGHT** to send a very light original. Use **S.DARK** to send a very dark original.

- 1 Place the original face down in the ADF.
- 2 Press **Menu/Set, 3, 3**.  

- 3 Press  to select **AUTO**, **S.LIGHT** or **S.DARK**, and then press **Menu/Set**.
- 4 Press **2** if you are finished choosing settings, and go to Step 5—**OR**—Press **1** if you want to select additional settings. The display returns to the Setup Send menu.
- 5 Enter a fax number, and then press **Fax Start** to send a fax—**OR**—Press **Copy** to make a copy.

### Resolution

When you have an original in the ADF, you can use the **Resolution** key. Press **Resolution** continuously until you see your selection on the LCD.

**STANDARD**—suitable for most typed originals.

**FINE**—good for small print; transmits a little slower than standard resolution.

**S. FINE**—good for small print or artwork; transmits slower than fine resolution.



**PHOTO**—use when original has varying shades of gray; slowest transmission time.

# Advanced Sending Operations

## Overseas Mode

If you have difficulty sending a fax overseas, use the Overseas mode.

After you send a fax using this feature, the feature turns itself off.

- 1 Place the original face down in the ADF.
- 2 Press **Menu/Set**, **3**, **5**.  

- 3 Press  to select **ON** (or **OFF**), and then press **Menu/Set**.
- 4 Press **1** if you want to select additional settings. The LCD returns to the Setup Send menu—**OR**—Press **2** if you are finished choosing settings, and then go to Step 5.
- 5 Enter the fax number you're calling.
- 6 Press **Fax Start**.

## Delayed FAX

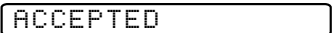
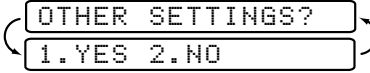
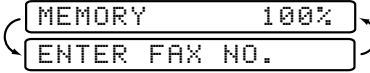
You can use this setting to send a fax up to 24 hours later.

- 1 Place the original face down in the ADF.
- 2 You can press **Quick-Scan** to use memory transmission—**OR**—Leave the original in the ADF to be scanned at the specified time.
- 3 Press **Menu/Set**, **3**, **7**.  

- 4 Enter the time you want the fax to be sent, in 24-hour format, and then press **Menu/Set**. (For example, enter 19:45 for 7:45 PM)
- 5 Press **Menu/Set**. The LCD shows:  

- 6 Press **1** if you want to select additional settings. The LCD returns to the Setup Send menu.  
—**OR**—  
Press **2** if you are finished choosing settings and go to Step 7. The LCD prompts you to enter the fax number.  
  

- 7 Enter the fax number.
- 8 Press **Fax Start**. The machine will wait to send the fax at the time you set up.



## Setting Up for Polled Transmit

Polled Transmit is when you set up your fax machine to wait with an original so another fax machine can retrieve it.

For more information call our Brother fax-back system at 1-800-521-2846 (**in USA**), 1-800-681-9838 (**in Canada**) and request the Index. (See *Features That Are Not in the Manual*, page 6-6 for details.)

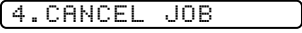

## Canceling a Scheduled Job

You can cancel tasks you've scheduled, such as Delayed Fax or Polling Transmit.

- 1 Press **Menu/Set**, **4**. Any waiting jobs appear on the LCD. If there are no jobs waiting, the LCD shows **NO JOB WAITING**.  

- 2 If you have more than two jobs waiting, press  to select the job you want to cancel, and then press **Menu/Set**.  
—OR—  
If you have only one job waiting, go to Step 3.
- 3 Press **1** to cancel—OR—Press **2** to exit without canceling.
- 4 Press **Stop/Exit**.

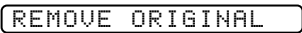
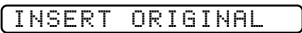
## Interrupting Delayed Fax and Polled Transmit Jobs

You can send a fax or make a copy now, even if you have the fax machine set to send a fax later or if you have it set to be polled. However, you cannot use automatic redial or the Menu mode.

- 1 Press **Menu/Set**, **5**.
  - 2 Wait two seconds, and then remove the original that is waiting in the ADF.  

  - 3 Place the original you want to send now face down in the ADF.  

  - 4 Enter the number for the fax you want to send now.
  - 5 Press **Fax Start**.
  - 6 After the transmission is finished, return the first original to the ADF.
  - 7 Press **Menu/Set**, **5** to restore the Delayed Fax and/or Polling.
-  If you have set up a Delayed Fax or Polled Transmit job in memory, you don't have to interrupt it to send a fax or make a copy.
-  If you have set up a Delayed Fax or Polled Transmit job, the machine will send an original without storing it in memory.

## Features That Are Not in the Manual (Call Brother fax-back system)

Your machine has additional features and operations that are not included in this manual. To receive faxed instructions, please call our automated Brother fax-back system at 1-800-521-2846 and request the Index. In the Index under *Features That Are Not in the Manual*, find the document numbers to request the following scripts:

- Polling
- Cover Page
- Call Reservation
- Print Sample of Call Back Message
- Next Fax Reservation
- Multiple Resolution Transmission
- Glossary



(For USA Only) The Brother fax-back system number has been preprogrammed on One Touch key **1**.

# 7 Auto Dial Numbers and Dialing Options

## Storing Numbers for Easy Dialing

You can set up your fax machine to do three types of easy dialing: One Touch, Speed Dial and Groups for Broadcasting of faxes.



*If you lose electrical power, auto dial numbers in memory will not be lost.*

### Storing One Touch Dial Numbers

You can store eight fax/phone numbers that you can dial by pressing one key (and **Fax Start**). To access numbers 05 to 08, hold down **Shift**. You also can store names with these numbers. When you press a One Touch dial location, the LCD shows the name or number as the call is dialed. (See *One Touch Dialing*, page 7-4.)

*One Touch keys are not the dial pad keys. They are the four keys (numbers 01–08) located on the left side of the control panel.*

- 1 Press **Menu/Set**, **6**, **1**.

1. ONE-TOUCH DIAL

- 2 Press the One Touch key where you want to store a number.



For your convenience, One Touch key **1** is pre-programmed for the Brother fax-back system. One Touch key **2** has been programmed with a telephone number associated with a feature that is no longer available. You can change these numbers if you wish by storing your own auto dial numbers in their place. (Please see *Changing One Touch and Speed Dial Numbers*, page 7-3.)

- 3 Enter a number (up to 20 digits), and then press **Menu/Set**.

NAME:



If you want to enter a pause in the dialing sequence (to wait for an “outside line,” for example), press **Redial/Pause** as you’re entering digits. Pressing **Redial/Pause** enters a 3.5-second pause when the number is dialed, and a dash appears on the LCD.

- 4 Use the dial pad to enter the name or company (up to 14 characters), and then press **Menu/Set**. —OR—To store the number without a name, press **Menu/Set**. (See *Details for Entering Text*, page 4-2.)

- 5 Press  to select the type of number, and then press **Menu/Set**.

**FAX** a fax only number

**TEL** a telephone (voice) number

**FAX/TEL** both a fax and telephone (voice) number

**CHAIN** a number (usually an access code) for chain dialing.

- 6 Return to Step 2 to store another One Touch number—**OR**—Press **Stop/Exit**.

When you dial an AUTO DIAL number the LCD shows the name you've stored, or if you haven't stored a name, the number you've stored.



If you must wait for another dial tone at any point in the dialing sequence, store a pause at that place in the number by pressing **Redial/Pause**. Each key press adds a 3.5 second pause.

You can use chain dialing to store long dialing sequences. For example, to store **9 1 201 555 1234 987 65 4321**, divide the number into two parts. Store the first part as a Chain type number (this tells the system that the dialing sequence is not complete).

**CHAIN—9 1 201 555 1234**





The last part of the One Touch number must be stored as any of the other following three types.

**FAX or FAX/TEL or TEL—987 65 4321**

Now when you dial, just press the two keys (one after the other in order) where you've stored the two parts of the number.

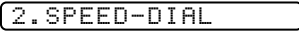
## Storing Speed Dial Numbers

You can store Speed Dial numbers, so you can dial by pressing only four keys and **Fax Start**. There are 50 Speed Dial locations.

- 1 Press **Menu/Set, 6, 2**.  

- 2 Use the dial pad to enter a two-digit location (01–50), and then press **Menu/Set**.  

- 3 Enter the number (up to 20 digits), and then press **Menu/Set**.  

- 4 Use the dial pad to enter the name or company (up to 14 characters), and then press **Menu/Set—OR—Press Menu/Set** to store the number without a name. (See *Details for Entering Text*, page 4-2.)  

- 5 Press  to select the type of number, and then press **Menu/Set**.

**FAX** a fax only number

**TEL** a telephone (voice) number

**FAX/TEL** both a fax and telephone (voice) number



**CHAIN** a number (usually an access code) for chain dialing.

- 6 Return to Step 2 to store another Speed Dial number—**OR**—Press **Stop/Exit**.



## Changing One Touch and Speed Dial Numbers

If you try to store a One Touch or Speed Dial number in a location where a number is already stored, the LCD shows the current name stored there, then prompts you to either **1. CHANGE—OR—2. EXIT.**



- 1 Press **1** to change the number stored, or press **2** to exit without making a change.
- 2 Enter a new number.
  - If you want to erase the whole number, press **Stop/Exit** when the cursor is to the left of the digits. The letters above and to the right of the cursor are deleted.
  - If you want to change a digit, use  or  to position the cursor under the digit you want to change, and then type over it.
- 3 Follow the directions beginning at Step 3 in Storing One Touch Numbers or Storing Speed Dial Numbers.



Please note that a telephone number associated with a feature that is no longer offered has been stored in One Touch Key **2**. Please follow the steps above to store your own auto dial number in its place.

## Setting Up Groups for Broadcasting

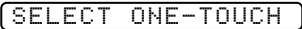
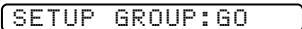
Groups allow you to send the same fax message to many fax numbers by pressing only one One Touch key (Broadcasting). **First**, you'll need to store each fax number as a One Touch or Speed Dial number. **Then**, you can combine them into a Group. **Each Group uses up a One Touch key.** **Finally**, you can have up to four small Groups, or you can assign up to 57 numbers to one large Group. (See *Storing One Touch Dial Numbers*, page 7-1, *Storing Speed Dial Numbers*, page 7-2 and *Broadcasting*, page 7-6.)

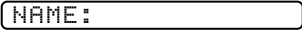
- 1 Press **Menu/Set, 6, 3.** 
- 2 Select the One Touch key where you wish to store the number. (For example, press One Touch key **3** to store a Group.) 
- 3 Use the dial pad to identify the Group with a number, and then press **Menu/Set.** (For example, press **1** for Group 1.) 
- 4 To include One Touch or Speed Dial numbers in the Group, enter them as if you were dialing. For example, for One Touch key 4, press One Touch key **4**. For Speed Dial location 09, press **Search/Speed Dial**, and then press **0, 9** on the dial pad. The LCD shows **\*04#09.** 
- 5 Press **Menu/Set** to accept the numbers for this Group. 
- 6 Use the dial pad to enter a name for the Group, and then press **Menu/Set.** (For example, NEW CLIENTS) (See *Details for Entering Text*, page 4-2.)
- 7 Press **Stop/Exit.**



You can print a list of all One Touch and Speed Dial numbers. (See *Printing Reports*, Chapter 11.)

# Dialing Options

---

You can use your fax machine to make voice telephone calls by dialing manually or by using Search, One Touch or Speed Dial memory. You can use the handset to make and receive calls.

When you dial an auto dial number, the LCD shows the name you've stored, or if you haven't stored a name, the fax number you've stored.

## Manual Dialing

Manual dialing is simply pressing all of the digits of the phone number.

- 1 Pick up the handset—**OR**—Press **Speaker Phone**.
- 2 When you hear a dial tone, dial the call using the dial pad.
- 3 You can switch from handset to Speaker phone by pressing **Speaker Phone**, then replacing the handset.  
You can switch from Speaker phone to handset by lifting the handset.
- 4 To hang up, replace the handset.

## One Touch Dialing

- 1 Pick up the handset—**OR**—Press **Speaker Phone**. (See *Storing One Touch Dial Numbers*, page 7-1.)
- 2 When you hear a dial tone, press the One Touch key of the location you want to call.
- 3 If you pressed **Speaker Phone** to dial the call, pick up the handset when the other party answers. (The speaker works only one way; the other party won't be able to hear you unless you pickup the handset.)
- 4 To hang up a voice call, replace the handset.



If you try to use a One Touch location with no number stored in it, you will hear a warning sound and LCD will show **NOT REGISTERED**. The LCD returns to normal after two seconds.



If you are sending a fax, press **Fax Start** after pressing the One Touch key. If you picked up the handset, press **Fax Start** when the receiving fax machine answers with fax tones.

## Speed Dialing

- 1 Pick up the handset—**OR**—Press **Speaker Phone**. (See *Storing Speed Dial Numbers*, page 7-2.)
  - 2 When you hear a dial tone, press **Search/Speed Dial**, press **#**, and then press the two-digit Speed Dial number.
  - 3 To hang up a voice call, replace the handset.
-  If you are sending a fax, press **Fax Start** after entering the Speed Dial number. If you picked up the handset, press **Fax Start** when the receiving machine answers with fax tones.

## Dialing Access Codes and Credit Card Numbers



Sometimes you may want to choose from among several long distance carriers when you make a call. Rates may vary depending upon the time and destination. To take advantage of low rates, you can store the access codes or long-distance carriers as One Touch and Speed Dial numbers. You can store these long dialing sequences by dividing them and setting them up separately in any combination. You can even include manual dialing using the dial pad. The combined number will be dialed in the order you enter it, as soon as you press **Fax Start**. Make sure you select CHAIN as the type of the number when you store it as a One Touch or Speed Dial. (See *Storing One Touch Dial Numbers* and *Storing Speed Dial Numbers*, page 7-1 to 7-2.)

 For example:  
You store “555” on One Touch key **3** and “7000” on One Touch key **4**. If you press One Touch **3, 4** and **Fax Start** you will dial “555-7000”. To temporarily change a number, you can substitute part of the number with manual dialing using the dial pad. For example, to change the number to 555-7001 you can press One Touch **3**, and then press **7, 0, 0, 1** using the dial pad.

 Pause after dialing Speed Dial numbers for the name to be displayed before you enter the next portion of the dialing sequence.

## Search

You can search for names you have stored in One Touch and Speed Dial memories. Names are shown alphabetically or numerically. (See *Storing One Touch Dial Numbers*, page 7-1 and *Storing Speed Dial Numbers*, page 7-2.)

- 1 Press **Search/Speed Dial**.
- 2 Press  or  to search alphabetically and  to search numerically.

 **Note** After you press **Search/Speed Dial**, you can do an alphabetical search by entering the first letter of the name.

- 3 When the LCD shows the name you want to call, pick up the handset for a voice call.
- 4 Press **Fax Start** to begin dialing.
- 5 When the call is over, hang up to end the call.

## Redial

If the last number you dialed was busy, press **Redial/Pause** for easy dialing.

## Answering Calls with the Speaker Phone

When the FAX rings, instead of lifting the handset, press **Speaker Phone**. Speak clearly, toward the microphone . To end the call, press **Speaker Phone**.

If you have a bad telephone line connection, the other party might hear your voice echoed during the call. Hang up and try the call again—**OR**—Pick up the handset.

## Broadcasting

Using the numbers you have stored in Groups, One Touch and Speed Dial memory, you can “Broadcast” faxes automatically to a maximum of 57 different locations in a few simple steps.

After the Broadcast is completed, a Broadcast Report will be printed automatically to let you know the results.

- 1 Insert the original in the ADF.
- 2 Press **Quick Scan**. The LCD shows how much memory is available.
- 3 Enter the One Touch and Speed Dial numbers (one after the other) or a Group number you have stored.
- 4 Press **Fax Start**. The FAX stores the document in memory, and then transmits it to all the numbers you entered. If the line is busy, your machine will redial.



Press **Stop/Exit** during transmission to cancel the current fax Broadcast.

## Pause

Press **Redial/Pause** to insert a pause between numbers. Each key press adds a 3.5 second delay.

## Hold

- 1** Press **Hold/Caller ID** to put a call on Hold.
- 2** You can put down the handset without disconnecting the call.
- 3** Pick up the fax machine handset to release the call from Hold. Picking up an extension handset will not release the call from Hold.

## Tone/Pulse (For Canada Only)

If you have pulse dialing service but need to send tone signals (for example, for telephone banking), follow the directions below. If you have touch tone service, you do not need this feature to send tone signals.

- 1** Lift the handset.
- 2** Press **#**. Any digits dialed after this send tone signals.
- 3** When you hang up, the fax machine returns to pulse dialing service.

# 8 Telephone Services

## Custom Features

---

Your fax machine supports the Distinctive Ring, Caller ID and Call Waiting/Caller ID telephone services offered by some telephone companies.



If you have Voice Mail, only Call Waiting, RingMaster, an answering service, or an alarm system custom feature on your telephone line, it may create a problem in the operation of your fax machine. (See *Custom Features on a Single Line*, page 13-8.)

If you have Voice Mail on your phone line, please read the following carefully.

### Distinctive Ring

The term “Distinctive Ring” is used by Brother to identify a telephone company service that is given *many names, depending on the telephone company you are using*. For example, this service may be called SmartRing, RingMaster, Teen-Ring, Ident-a-Call or Ident-a-Ring.

#### What Does Your Telephone Company’s “Distinctive Ring” Do?

Your telephone company’s Distinctive Ring service allows more than one number to be on same phone line. **If you need more than one phone number, it is an inexpensive alternative to paying for an additional line.** Each phone number has its own distinctive ring pattern, so you’ll know which phone number is ringing. This is one way you can have a separate phone number for your fax machine.



Please consult your telephone company for availability and **rates**.

#### What Does Brother’s “Distinctive Ring” Do?

The Brother machine has a Distinctive Ring feature that allows you to use your fax machine to take full advantage of the telephone company’s Distinctive Ring service. You can dedicate the new phone number on your line to receive only faxes.



You must purchase your telephone company’s Distinctive Ring service *before* you program the Brother machine to work with it.

## Do You Have Voice Mail?

If you have Voice Mail on the phone line you will install your new fax machine on, *there is a strong possibility that Voice Mail and the fax machine will conflict with each other while receiving incoming calls.* **However, this Distinctive Ring feature allows the use of more than one number on your line, so both Voice Mail and the fax machine can coexist peacefully.** If each one has a separate phone number, neither will interfere with the other's work.





If you decide to get the Distinctive Ring service from the telephone company, you will need to follow the directions below to "register" the new Distinctive Ring pattern they provided, so your fax machine can recognize its incoming calls.



You can change or cancel the Distinctive Ring pattern at any time. You can switch it off temporarily, then turn it back on. When you get a new fax number, make sure you reset this menu selection.

## Before You Choose the Ring Pattern to Register

You can register only one Distinctive Ring pattern with the fax machine. Some ring patterns cannot be registered. Please refer to some popular ring pattern examples that will be provided from the telephone company in the USA and Canada that are shown in the Brother compatibility table below.

Ring Pattern	Rings	
1	long - long	
2	short - long - short	
3	short - short - long	
4	very long (normal pattern)	





If the ring pattern the telephone company provided cannot be registered by the fax, **please check for other available ring pattern choices from the telephone company.**

- The fax machine will answer only calls to its registered number.
- The first two rings are silent on the fax machine. This is because the fax must « listen » to the ring pattern (compare it to the pattern that was "registered").
- If you program the fax machine correctly, it will recognize the registered ring pattern of the "fax number" within two ring patterns and automatically answer with a fax tone. When the "voice number" is called, the fax machine will not interrupt the call.

## VERY IMPORTANT

If you have Voice Mail or a TAD (Telephone Answering Device) and want to keep one of your phone numbers dedicated only to fax calls, you must leave the fax machine in **MANUAL** mode at all times while using the Distinctive Ring feature. Here's why: Manual mode will never pick up a call by itself, since it is «Neutral ». When the fax machine is in this «neutral » mode, the Distinctive Ring feature can be activated. The Distinctive Ring feature is actually an answering mode. So, do not activate FAX ONLY mode or FAX /TEL mode while using Distinctive Ring; otherwise, the fax machine will answer calls for *all* the numbers.

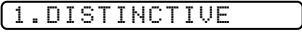
### Registering the Distinctive Ring Pattern

- 1 Set the fax machine to MANUAL mode.
- 2 Press **Menu/Set, 0, 1.** 
- 3 Press  to select **DISTINCTIVE:SET?**, and then press **Menu/Set.**
- 4 Press  to select the prestored ring pattern you want to assign, and then press **Menu/Set.** (You will hear each pattern as you scroll through the four patterns.) Be sure to choose the pattern assigned by the telephone company.
- 5 Press **Stop/Exit.**

### Caller ID

The Caller ID feature of this fax machine lets you use the Caller ID subscriber service offered by many local telephone companies. After at least two rings, the LCD shows the telephone number of your caller (or up to 16 characters of the name, if available). Once you pick up the handset the Caller ID information disappears from the LCD, but the call information remains stored in the Caller ID memory.

- **CALL PICKUP** remains on the LCD when no Caller ID information was transmitted.
- **OUT OF AREA** means the call originates outside your Caller ID service area.
- **PRIVATE CALL** means the caller has intentionally blocked transmission of information.

Caller ID service varies with different carriers. Call your local telephone company to determine the kind of service available in your area.

### Caller ID Log

Your fax machine stores up to 30 of the last Caller IDs received into the fax machine's memory in the Caller ID Log. When the thirty-first call comes in, information about the first call is erased. You can print the report or scroll through Caller ID information to review those calls made to your fax machine.



## Printing the Caller ID Log

- 1 Press **Hold/Caller ID**.
- 2 To print the Caller ID Log, press **Fax Start**.

CALLER ID LOG

PRESS START KEY

## Viewing the Caller ID Log

- 1 Press **Hold/Caller ID**.
- 2 After two seconds, press  to scroll through the Caller ID Log.
- 3 When you want to see detailed information for a displayed ID (phone number and date and time call was received) press **Menu/Set**.
- 4 To continue viewing the Caller ID Log

CALLER ID LOG

01>MARY HENDERSON

02>TOM HENDERSON

03>ABC COMPANY

03>ABC COMPANY

03>9087772837

03>02/01 12:00

DIAL:PRESS START

(Step 2), press .

—OR—

To exit the Caller ID Log, press **Stop/Exit**.

## Returning a Call from the Log

You can scroll through the Caller ID Log and select a call to return automatically. (See page 8-3)

(For USA Only) You must set up your AREA CODE in advance. (See *Setting Up Your Area Code (For USA Only)*, page 4-6.)

- 1 Press **Hold/Caller ID**.
- 2 Press  to scroll through the Caller ID Log and when you see a call you want to return immediately, press **Menu/Set**.
- 3 To begin dialing, press **Fax Start**.
- 4 Begin speaking when the other party answers.

CALLER ID LOG

01>MARY HENDERSON

01>9082438436

01>02/01 12:00

DIAL:PRESS START



This feature may not be available in certain areas of USA and Canada. If your dialing plan does not follow the standard 1 + area code + 7-digit number dialing system for calling outside your area code, you may experience problems returning calls automatically from the Caller ID Log. Your fax machine will automatically dial “1” plus the area code for any number that does not originate in your area code. If this is not the procedure followed by your dialing plan you will not be able to return calls automatically.

## Registering a Caller ID Number

You can set up a caller in the Caller ID Log as a One Touch or Speed Dial number.

- 1 Press **Hold/Caller ID**.

CALLER ID LOG

- 2 After two seconds, press  to scroll

through the Log and when you see a caller you want to register, press **Menu/Set**.

- 3 To register the caller as a One Touch number, press the One Touch key where you want the number to be stored.

—OR—

To register the caller as a Speed Dial number, press **Search/Speed Dial** and use the dial pad to press the two-digit location code (01–50), and then press **Menu/Set**.

03>ABC COMPANY  
03>9087772837  
03>02/01 12:00  
DIAL:PRESS START



If the LCD shows **REGISTERED**, the auto dial location already has a number.

- 4 Enter the caller’s name, and then press **Menu/Set**.

NAME:

- 5 Press  to select the type of number, and then press **Menu/Set**:

**FAX** A fax number

**TEL** A telephone (voice) number

**FAX/TEL** Both a fax and telephone number

**CHAIN** A number, usually an access code, for chain dialing

- 6 Return to Step 2 to store another auto dial number—OR—  
Press **Stop/Exit**.

## Call Waiting Caller ID

The Call Waiting/Caller ID feature lets you use the Call Waiting/Caller ID service offered by many local telephone companies. This feature displays the telephone number (or name, if available) of Call Waiting callers on your fax machine's LCD.

- 1** To answer a Call Waiting signal while you're talking on the phone, ask the other party if you can put them on Hold to catch the other call. The LCD shows the **Caller ID**.
- 2** Press **Search/Speed Dial** to switch to the second call.
- 3** To switch back to the first call, press **Search/Speed Dial** again.



Either caller can hang up at any time. However, if you hang up you will disconnect both callers.

# 9 Message Center

## Message Center Mode

---

Message Center Mode allows you to store incoming fax and voice messages in a flexible memory. The memory stores 15 minutes of voice messages, or up to 20 pages of fax memory. Any voice or fax message can be retrieved remotely. Memory is shared between fax and voice messages, which are stored on a “first-come, first-served” basis.

You must record an outgoing message in order to use the Message Center Mode. (See *Recording Message Center Outgoing Message*, page 9-2.)

### Flexible Memory Settings (Message Storage)

Message Center Mode offers you six flexible memory settings, so you can decide the kinds of messages you want to receive.

- |                            |   |
|----------------------------|---|
| <b>1.FAX:ON VOICE:ON</b>   | Both voice and fax messages are stored. You can use the Fax Forwarding or Paging features and retrieve voice and fax messages remotely.   |
| <b>2.FAX:ON VOICE:EXT</b>  | You need an external answering machine connected to the EXT jack for this setting. Fax messages are stored in the message center memory, but voice messages are stored in your external answering machine. Retrieve messages from the external answering machine. You cannot use the Paging feature for voice messages with this setting. |
| <b>3.FAX:ON VOICE:OFF</b>  | All memory is used to store fax messages—no voice messages will be stored.  |
| <b>4.FAX:OFF VOICE:ON</b>  | All memory is used to store voice messages—no fax messages will be stored. Incoming faxes will print on paper. You can use the Paging feature, and retrieve voice messages remotely.  |
| <b>5.FAX:OFF VOICE:EXT</b> | You need an external answering machine connected to the EXT jack for this setting. Incoming faxes are not stored in memory, but will print on paper. Voice messages are stored in the external answering machine.   |
| <b>6.FAX:OFF VOICE:OFF</b> | Incoming faxes are not stored in memory, but will print on paper. Voice calls are not stored in memory.   |



## Setting Up the Message Center

You must set up the Message Center in the following order:

- 1 Setting Message Storage.  
(See *Setting Message Storage*, page 9-2.)
- 2 Record Message Center Outgoing Message (MSG CTR OGM).  
(See *Recording Message Center Outgoing Message*, page 9-2.)
- 3 Activate Message Center Mode.  
(See *Activating Message Center Mode*, page 9-3.)



### Setting Message Storage

Read the *Flexible Memory Settings* descriptions on page 9-1 before you select the FAX and VOICE settings below.

- 1 Press **Menu/Set**, **8**, **1**.
- 2 Press  to select **ON** (or **OFF**), and then press **Menu/Set**.
- 3 Press  to select your setting from the list on pages *Flexible Memory Settings (Message Storage)*, page 9-1 (**ON**, **EXT**, **OFF**) and then press **Menu/Set**.
- 4 Press **Stop/Exit** to exit.

### Recording Message Center Outgoing Message

Recording the Message Center Outgoing Message (MSG CTR OGM) is the second step you need to follow before you can turn on the Message Center. Make sure your OGM is less than 20 seconds long.





- 1 Press **Menu/Set**, **8**, **3**.   
The LCD prompts you to choose an OGM.
- 2 Press  to select **MSG CTR OGM?** (not **F/T OGM**), and then press **Menu/Set**.   
**This is the only setting you can select if you want to turn on the Message Center.**
- 3 Press  to select **RECORD OGM?**, and then press **Menu/Set**.

- Pick up the handset to record a message.

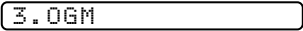

**For example:** *Hello. We are unable to take your call at this time. Please leave a message after the signal. If you wish to send a fax, please press \*5 1, wait for fax tones, then press the Start button.*

- Replace the handset. The Message Center will play your OGM.
- Press **Stop/Exit**.

### Listening to Outgoing Message (OGM)

- Press **Menu/Set, 8, 3**. 
- Press  to select **MSG CTR OGM?** (or **F/T OGM**), and then press **Menu/Set**.
- Press  to select **PLAY OGM?**, and then press **Menu/Set**. Adjust the volume by pressing Volume .
- Press **Stop/Exit**.

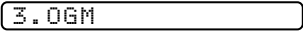
### Erasing Outgoing Message (OGM)

- Press **Menu/Set, 8, 3**. 
- Press  to select **MSG CTR OGM?** (or **F/T OGM**), and then press **Menu/Set**.
- Press  to select **ERASE OGM?**, and then press **Menu/Set**.
- Press **1** to erase the **OGM**—**OR**—Press **2** to exit without erasing.
- Press **Stop/Exit**.

### Activating Message Center Mode

Press and hold  until it lights and the LCD shows:



When  light is out, the Message Center is off. (See *Setting Up the Message Center*, page 9-2.)

## Message Indicator

The  light flashes when you have *new* messages or faxes waiting for your review.

The LCD displays the total number of voice and fax messages stored in the Message Center memory.



VOICE:03 FAX:02

If you press the flashing  to turn off the Message Center before getting your new messages, they won't be lost. The new messages will be played automatically and the LCD will ask you to acknowledge the new faxes:

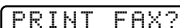

PRINT FAX?



1.YES 2.NO

Press **1** to print (and automatically delete) the faxes from memory. —OR— Press **2** to save the faxes in memory until printing is convenient.

## Playing Voice Messages

Follow the steps below to listen to voice messages:

- 1 Press **Play/Record**. Adjust the Volume by pressing  .

All messages are played in the order they were recorded. The LCD shows the number of the current message, and the total number of messages.

If Caller ID information was received, the fax machine beeps during the message and displays the Caller ID information for one second.

During playback, the LCD shows the time and date the message was recorded.

- 2 Press **\* (RWD)** at the end of the message to repeat a message. Press **# (FWD)** to skip to the next message. You can press **\*** and **#** repeatedly until you reach the message you want to play.
- 3 Press **Stop/Exit**.

## Printing a Fax Message

Once you print a new fax message stored in memory, it is erased from the memory automatically.

- 1 Press **Play/Record**. After two seconds, the fax machine begins to play voice messages.
- 2 If there are fax messages in memory, the LCD shows:
- 3 To print the faxes, press **1**.



PRINT FAX?

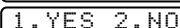



1.YES 2.NO

—OR—

Press **2** to exit without printing.

## Backup Printing Option

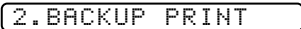
When you choose FAX: ON in the Message Center mode, all incoming fax messages are stored in the available memory for retrieval. To print a backup copy automatically, turn this option on.

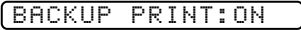
- 1 Press **Menu/Set, 8, 2.** 
- 2 Press  to select **ON** (or **OFF**), and then press **Menu/Set.** 
- 3 Press **Stop/Exit.**

## Erasing Messages



If you choose to erase all *fax* messages, the fax machine will print any previously unprinted faxes before erasing them from memory. Fax messages cannot be erased individually.

You can erase *voice* messages individually, or all at once.

### To Erase Voice Messages Individually

- 1 Press **Play/Record.** The fax machine sounds a two-second beep and begins message playback. Each message is preceded by one long beep, and followed by two short beeps.
- 2 To erase a specific message, press **Erase**  immediately after the two short beeps, or while the message is playing.
- 3 Press **1** to erase the message—**OR**—Press **2** to cancel.
- 4 Press **Stop/Exit.**

### To Erase Messages All at Once

- 1 Press **Erase.** 
- 2 Press  to select erasing all voice messages (**VOICE**), all document messages (**FAX**), or all messages—both voice and fax—(**MSG**), and then press **Menu/Set.**
- 3 Press **1** to erase. —**OR**—Press **2** to cancel.
- 4 Press **Stop/Exit.**



## Setting Maximum Time for Incoming Messages

Your fax machine comes set to receive voice messages up to 30 seconds long. You can change this setting to any length from 20 seconds to 60 seconds, in 5-second increments.

- 1 Press **Menu/Set, 8, 4.**

4. ICM MAX. TIME

- 2 Press  to select the maximum time setting for incoming messages, and then press **Menu/Set.**

MESSAGE 30 SEC?

- 3 Press **Stop/Exit.**

## Setting Toll Saver

When you set the toll saver feature, the fax machine answers after four rings if you *don't* have messages, and after two rings if you *do* have messages. This way, when you call the fax machine and let it ring three times, you know you have no messages, and can hang up, to avoid a toll charge.



When Toll Saver is **ON**, it overrides your Ring Delay setting. Toll Saver must be off for the fax machine to operate using your Ring Delay setting. (See *Setting Ring Delay*, page 5-2.)

- 1 Press **Menu/Set, 2, 1.**

1. RING DELAY

- 2 Press  to select the **TOLL SAVER** (or **RING DELAY**), and then press **Menu/Set.**

- 3 Press  to select **ON**, and then press **Menu/Set.**

- 4 Press **Stop/Exit.**

## ICM Recording Monitor

This feature lets you turn the speaker volume for voice messages **ON** or **OFF**. When you turn the monitor **OFF**, you will not hear messages as they come in.

- 1 Press **Menu/Set, 8, 5.**

5. ICM REC. MONITR

- 2 Use  to select **OFF** (or **ON**), and then press **Menu/Set.**

- 3 Press **Stop/Exit.**

## Recording a Conversation

You can record a telephone conversation by pressing **Play/Record** during the conversation. Your recording can be as long as the Incoming Message Maximum Time. You and the other party will hear a beep every 15 seconds while recording. To stop recording, press **Stop/Exit**. You cannot record a conversation using Speaker Phone.

## Fax Forwarding/Paging

When Paging is set to **ON**, your fax machine dials the pager number you've programmed, and dials your Personal Identification Number (PIN) when connected, this activates your pager and lets you know you have a fax or voice message in the Message Center memory.

When Fax Forwarding is set to **ON**, your fax machine dials the fax machine phone number you've programmed and forwards any faxes you've received.





You can *not* use Paging and Fax Forwarding at the same time.

## Programming a Fax Forwarding Number

1 Press **Menu/Set**, **8**, **6**.

6.FAX FWD/PAGING

2 Press  **OR**  until the LCD shows **FAX**

**FORWARD?**, and then press **Menu/Set**.

3 Enter the number of the fax machine where faxes will be forwarded (up to 20 digits), and then press **Menu/Set**.

FWD#:  
ENTER & SET

4 Press **Stop/Exit**.



You can change a Fax Forwarding number remotely. (See *Changing Fax Forwarding Number*, page 9-12.)

## Programming Paging Number

1 Press **Menu/Set**, **8**, **6**.

6.FAX FWD/PAGING

2 Press  until the LCD shows **PAGING?**, and then press **Menu/Set**.

3 Enter your pager phone number (up to 20 digits) followed by **# #**, and then press

**Menu/Set**. For example, **1 8 0 0 5 5 5 1 2 3**

**4 # #**. Do not include the area code if it is the same as that of your fax machine.

PAG#: \_\_\_\_\_  
ENTER & SET \_\_\_\_\_

4 If your pager requires a PIN, enter the PIN, press **#**, press **Redial/Pause**, enter your fax machine telephone number followed by **# #**, and then press **Menu/Set**.

For example, **1 2 3 4 5 # Redial/Pause 1 8 0 0 5 2 1 2 8 4 6 # #**.

—OR—

If you do not need a PIN, press **Redial/Pause**, enter the telephone number of your fax machine followed by **# #**, and then press **Menu/Set**. For example, **Redial/Pause 1 8 0 0 5 2 1 2 8 4 6 # #**.

5 Press **Stop/Exit**.



You can *not* change a Paging number or PIN remotely.

# Remote Retrieval

---

## Using Remote Access Code

- 1 Dial your fax number from a touch tone phone.
- 2 When your fax machine answers, immediately enter your Remote Retrieval Access Code.
- 3 The fax machine signals the kinds of messages received:
  - 1 long beep—Fax message(s)
  - 2 long beeps—Voice message(s)
  - 3 long beeps—Fax and Voice message(s)
  - No beeps—No messages
- 4 The fax machine then prompts you with two short beeps to enter a command. If you wait longer than 30 seconds to enter a command, the fax machine hangs up. If you enter an invalid command, the fax machine beeps three times.
- 5 Press **9 0** to reset the fax machine when you finish.
- 6 Hang up.



If your fax machine is set to **MANUAL** mode, you can access the Message Center by waiting about two minutes, then entering the Remote Access Code within 30 seconds.

## Changing Remote Retrieval Access Code

Enter your Remote Retrieval Access Code when the fax machine picks up your call, so you can access features remotely. The access code is preset to 159✳, but you can change it.

- 1 Press **Menu/Set, 8, 7**.
- 2 Enter a three-digit number from 000 to 999 and press **Menu/Set**. The “✳” cannot be changed.

7. REMOTE ACCESS





Do not use the same digits that appear in your Fax Receive Code or Telephone Answer Code.

- 3 Press **Stop/Exit**.

## Remote Commands

Follow the commands below to access features remotely. When you call the fax machine and enter your Remote Retrieval Access Code (159✳), the system will signal you with two short beeps to enter a remote command.

Remote Commands		Operation Details	
<b>91</b>	<b>Playing Voice Messages</b>	After one long beep, the fax machine plays the ICM.	
	1  (Skip to back)	Press <b>1</b> while listening to an ICM to repeat it. If you press <b>1</b> before a message, you will hear the previous message.	
	2  (Skip next)	While playing the ICM, you can skip to the next message.	
	9 STOP Playing	Stop playing the ICM.	
<b>92</b>	<b>Record Memo</b>	After one long beep, you can record a memo. To stop recording, press <b>9</b> .	
<b>93</b>	<b>Erase all ICM</b>	If you hear one long beep, the erase is accepted. If you hear three short beeps, you cannot erase because all voice messages have not been played, or there is no voice message to erase. *This code erases all recorded messages, not one at a time.	
<b>94</b>	<b>Play and Record OGM in Memory</b>		
	1 Play	1 MSG CTR OGM	The fax machine plays the selected OGM. You can stop playing OGMs by pressing <b>9</b> .
		2 F/T OGM	
	2 Record	1 MSG CTR OGM	After one long beep, you can record the selected OGM. You will hear the message played once. You can stop recording the message by pressing <b>9</b> .
	2 F/T OGM		
<b>95</b>	<b>Changing Fax Forwarding/Paging Setting</b>		If you hear one long beep, the change is accepted. If you hear three short beeps, you cannot change it because the conditions have not been met. (Example: registering paging number.) You can register your fax forwarding number by using 4. FAX FWD NO. (See page 9-12.) Once you have registered the number, the fax machine automatically will change to FAXFWD:ON mode. Then retrieve a Memory Status List by entering <b>9 6 1</b> (See page 9-11.) to make sure that the Fax Forwarding number you registered is correct in the List.
	1 OFF		
	2 Fax Forwarding		
	3 Paging		
	4 Fax Fwd No.		

Remote Commands		Operation Details
<b>96 Retrieve a Fax</b>	1 Memory Status List	Enter the number of a remote fax machine to receive a report or stored fax messages. (See page 9-11.)
	2 Retrieve all faxes	
	3 Erase fax in the memory	If you hear one long beep, you can erase the fax message from the memory.
<b>97 Check the Receiving Status</b>	1 FAX	You can check whether your fax machine has received any FAX or VOICE messages. If yes, you will hear one long beep. If no, you will hear three short beeps.
	2 VOICE	
<b>98 Change Answer Mode</b>	1 MSG CTR	If you hear one long beep, you can change the answer mode. If you hear three short beeps, you cannot change it. (Example: There is no MSG CTR OGM when you want to change to MSG CTR mode.)
	2 FAX/TEL	
	3 FAX ONLY	
<b>90 Exit</b>		After a long beep, you can exit Remote Retrieval.

## Retrieving Memory Status List

You can retrieve the Memory Status List from a remote fax machine to see if you have any fax messages.

- 1 Dial your fax number.
  - 2 When you hear the beep, immediately enter your Remote Retrieval Access Code (1 5 9 \*).
  - 3 When you hear two short beeps, use the dial pad to press **9 6 1**.
  - 4 Using the dial pad, enter the number of the remote fax machine (up to 20 digits) where you want the Memory Status List forwarded followed by **# #**.
-  You can *not* use \* or # as dial numbers. However, if you want to store a pause, press #.
- 5 After you hear your fax machine beep, hang up and wait.

Your fax machine calls the remote fax machine. The remote fax machine prints the Memory Status List.

## Retrieving Fax Messages

- 1 Dial your fax number.
- 2 When you hear the beep, immediately enter your Remote Retrieval Access Code (**1 5 9 ✕**).
- 3 As soon as you hear two short beeps, use the dial pad to press **9 6 2**.
- 4 Using the dial pad, enter the number of the remote fax machine (up to 20 digits) where you want your fax messages forwarded followed by **# #**.



You can *not* use ✕ or # as dial numbers. However, if you want to store a pause, press #.

- 5 After you hear your fax machine beep, hang up and wait.  
Your fax machine calls the remote fax machine. The remote fax machine prints your fax messages.

## Changing Fax Forwarding Number

You can change the default setting of your fax forwarding number from a remote fax machine.

- 1 Dial your fax number.
- 2 When you hear the beep, immediately enter your Remote Retrieval Access Code (**1 5 9 ✕**).
- 3 When you hear two short beeps, use the dial pad to press **9 5 4**.
- 4 Enter the new number of the remote fax machine where you want your fax messages forwarded followed by **# #**.



You can *not* use ✕ or # as dial numbers. However, if you want to store a pause, press #.

- 5 To retrieve the Memory Status List, when you hear two short beeps, use the dial pad to press **9 6 1**.
- 6 Use the dial pad to enter the number of the remote fax machine (up to 20 digits) followed by **# #**.
- 7 After you hear your fax machine beep, hang up and wait.  
Your fax machine calls the remote fax machine. The remote fax machine prints the Memory Status List showing the new forwarding number.
- 8 Check the forwarding number.

If the forwarding number is not correct, return to Step 1 to reset it.

# 10 Making Copies

## Copy Operations

To make a single copy that is not reduced, enlarged or sorted, you have to press only the Copy key. The default resolution for a single copy is Super Fine. Set the resolution to PHOTO for photographs.

## Using the Fax Machine as a Copier

You can use the fax machine as a copy machine, making up to 99 copies at a time.

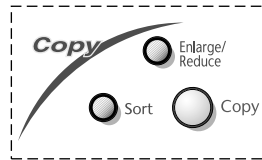

The scannable area of your fax machine begins at approximately 1/6"-1/8" (3 mm - 4 mm) from the edge of the paper.

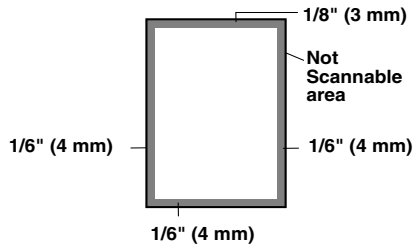

## Making a Single Copy

- 1 Place the original face down in the ADF.
- 2 Press **Copy** twice.

To cancel, press **Stop/Exit**.

Do NOT pull on the paper while copying is in progress.



## Multiple Copies

You can make multiple copies using your fax machine, and you can choose whether the copies will be **STACKED** (all copies of page 1, then all copies of page 2, etc.) or **SORTED** (collated). The default resolution for multiple copies is Fine.

1 Place the original face down in the ADF.

2 If you want copies “stacked,” press **Copy**.



—OR—

If you want copies “sorted” (collated), press **Sort**.

3 Enter the number (1–99) of copies you want.

4 Press **Copy**.



If you are making multiple copies and get an **OUT OF MEMORY** message while you are scanning the first page, press **Stop/Exit** to cancel the job. Then make a single copy. If you pressed **Sort** and the **OUT OF MEMORY** message appears while scanning subsequent pages, you can press **Copy** to copy the portion that is in memory, or press **Stop/Exit** to cancel. To restart the copy job using less memory, press **Copy** for stacked copies.

## Reducing and Enlarging Copies

When making copies, you can reduce or enlarge the size of the printed image. To reduce to the size of your selected paper automatically, select **AUTO**. To select a reduction ratio, choose **93%**, **87%**, **75%** or **50%**. To enlarge a document, select **150%**, **125%** or **120%**. To print a document at its original size, select **100%**.

1 Place the original face down in the ADF.

2 Press **Enlarge/Reduce**.

3 Use  to choose a ratio setting.

4 Press **Copy**. —OR— **Sort** if you want sorted copies.

5 Enter the number (1–99) of copies you want. For example, press **9** for nine copies.

6 Press **Copy**.

## FAX Settings and Activity

Two reports require initial setup in the Menu table: Transmission Verification Report and Fax Activity Report Interval. For initial setup:

Press **Menu/Set, 7, 1.**

1. TRANSMISSION

—OR—

Press **Menu/Set, 7, 2.**

2. ACT. INTERVAL

### Customizing the Transmission Verification Report

You can use the Transmission Report as proof that you sent a fax. This report lists the name or fax number of the receiving party, time and date of transmission and whether the transmission was successful (OK).



When the feature is **OFF**, the report prints only if a transmission *error* prevented delivery (NG).

1 Press **Menu/Set, 7, 1.**

1. TRANSMISSION

2 Press  to select **ON** (or **OFF**),  
and then press **Menu/Set**.

3 Press **Stop/Exit**.

### Setting the Fax Activity Report Interval

You can set the machine to print activity reports at specific intervals (6, 12, 24 hours, 2, 4, or 7 days). If you set the interval to **OFF**, you can print the report by following the steps in the next page.

1 Press **Menu/Set, 7, 2.**

2. ACT. INTERVAL

2 Press  to choose an interval,  
and then press **Menu/Set**.

(If you choose 7 days, the LCD prompts you to choose a day at which to begin the 7-day countdown.)

3 Enter the time to begin printing, in 24-hour format, and then press **Menu/Set**.  
(For example: enter 19:45 for 7:45 PM.)

4 Press **Stop/Exit**.

## Using the Reports Key



Press **Reports**, then press  to select the report you want, and then press **Menu/Set**.

Six reports are available:

- |                 |  |
|-----------------|--|
| 1.HELP LIST     | Prints the Menu Table and programming instructions so you can see at-a-glance how to quickly program every menu selection.                                       |
| 2.AUTO DIAL     | Lists names and numbers stored in One Touch and Speed Dial memory, in numerical order.   |
| 3.FAX ACTIVITY  | Lists information about the last 30 incoming and outgoing faxes. TX means Transmit; RX means Receive.  |
| 4.TRANSMISSION  | Prints a Transmission Verification Report for your last transmission. This information will remain until you pick up the handset or press <b>Speaker Phone</b> . |
| 5.USER SETTINGS | Lists settings for <b>INITIAL SETUP, SETUP RECEIVE, SETUP SEND, SETUP REPORTS, TEL SERVICE</b> and <b>SETUP MSG CTR</b> .  |
| 6.MEMORY STATUS | Lists summary information of stored faxes and the percentage of used memory.   |

 Don't forget to set up the Fax Activity Report and Transmission Verification Report as explained on page 11-1.

# 12 Important Information

## Standard Telephone and FCC Notices

---

**These notices are in effect on models sold and used in the United States only.**

**This equipment is hearing aid compatible.**

**When programming emergency numbers and/or making test calls to emergency numbers:**

- Remain on the line and briefly explain to the dispatcher the reason for the call before hanging up.
- Perform such activities in the off-peak hours, such as early morning or late evening.

This equipment complies with Part 68 of FCC Rules. On the rear panel of this equipment is a label that contains, among other information, the FCC Registration Number and Ringer Equivalence Number (REN) for this equipment. You must, upon request, provide this information to your telephone company.

You may safely connect this equipment to the telephone line by means of a standard modular jack, USOC RJ11C.

An FCC compliant telephone cord with a modular plug is provided with this equipment. This equipment is designed to be connected to the telephone line or premise's wiring using a compatible modular jack that is Part 68 compliant. See the Installation section of this manual for details.

The REN is useful to determine the quantity of devices you may connect to your telephone line and still have those devices ring when your telephone number is called. In most, but not all areas, the sum of the RENs of all devices connected to one line should not exceed five (5). To be certain of the number of devices you may connect to your line, as determined by the REN, you should contact your local telephone company to determine the maximum REN for your calling area. If your fax damages the telephone line, the telephone company may discontinue your service temporarily. If possible, they will notify you in advance. But if advance notice is not practical, you will be notified as soon as possible. You will be informed of your right to file a complaint with the FCC.

Your telephone company may make changes to its facilities, equipment, operations or procedures that could affect the proper functioning of your equipment. If they do, you will be notified in advance to give you an opportunity to maintain uninterrupted telephone service.

If you experience trouble with this fax machine, please contact a Brother authorized service center for information on obtaining service or repair. The telephone company may ask that you disconnect this equipment from the line until the problem has been corrected or until you are sure that the equipment is not malfunctioning. If you are not able to solve a problem with your fax machine, contact Brother Customer Service. (See *Brother Numbers*, page i.)

## International Energy Star Compliance Statement

The purpose of the International Energy Star Program is to promote the development and popularization of energy-efficient office equipment, which includes computers, monitors, printers, facsimile receivers and copy machines world-wide. As an International Energy Star partner, Brother Industries, Ltd. has decided that this product meets the guideline of the program.



## Industry Canada Compliance Statement (For Canada Only)

This Class B digital apparatus meets all requirements of the Canadian Interference-Causing Equipment Regulations.

Cet appareil numérique de la classe B respecte toutes les exigences du Règlement sur la matériel brouilleur du Canada.

## Federal Communications Commission Compliance Notice (For USA Only)

This equipment has been tested and found to comply with the limits for a Class B digital device, pursuant to Part 15 of the FCC Rules. These limits are designed to provide reasonable protection against harmful interference in a residential installation. This equipment generates, uses, and can radiate radio frequency energy and, if not installed and used in accordance with the instructions, may cause harmful interference to radio to radio communications.

However, there is no guarantee that interference will not occur in a particular installation. If this equipment does cause harmful interference to radio or television reception, which can be determined by turning the equipment off and on, the user is encouraged to try to correct the interference by one or more of the following measures:

- Reorient or relocate the receiving antenna.
- Increase the separation between the fax equipment and the receiver.
- Connect the fax equipment on a separate circuit.
- Consult with the dealer or an experienced radio/TV technician for help.

### **WARNING**

For protection against the risk of electrical shock, always disconnect all cables from the wall outlet before servicing, modifying or installing the equipment.

This equipment may not be used on coin service lines provided by the telephone company or connected to party lines.

Brother cannot accept any financial or other responsibilities that may be the result of your use of this information, including direct, special or consequential damages. There are no warranties extended or granted by this document.

The serial number may be found on the label affixed to the bottom of the unit. For your convenience, note the number below and retain this Owner's Manual to serve as a permanent record of your purchase in the event of a theft or fire, or for future reference. (See *Brother Numbers*, page i.)

## Important Safety Instructions

- 1 Read all of these instructions.
- 2 Save them for later reference.
- 3 Follow all warnings and instructions marked on the product.
- 4 Unplug this product from the wall outlet before cleaning. Do not use liquid or aerosol cleaners. Use a damp cloth for cleaning.
- 5 Do not use this product near water.
- 6 Do not place this product on an unstable cart, stand, or table. The product may fall, causing serious damage to the product.
- 7 Slots and openings in the cabinet and the back or bottom are provided for ventilation; to ensure reliable operation of the product and to protect it from overheating, these openings must not be blocked or covered. The openings should never be blocked by placing the product on a bed, sofa, rug, or other similar surface. This product should never be placed near or over a radiator or heater. This product should never be placed in a built-in installation unless proper ventilation is provided.
- 8 This product should be operated from the type of power source indicated on the label. If you are not sure of the type of power available, consult with your dealer or local power company.
- 9 This product is equipped with a 3-wire grounding type plug, a plug having a third (grounding) pin. This plug will fit into only a grounding-type power outlet. This is a safety feature. If you are unable to insert the plug into the outlet, contact your electrician to replace your obsolete outlet. Do not defeat the purpose of the grounding-type plug.
- 10 Do not allow anything to rest on the power cord. Do not place this product where people can walk on the cord.
- 11 If an extension cord is used with this product, make sure that the total ampere ratings on the products plugged into the extension cord do not exceed the extension cord ampere rating. Also, make sure that the total of all products plugged into the wall outlet does not exceed 15 amperes (USA Only).
- 12 Do not place anything in front of the fax machine that will block the original. Do not place anything in the path of received faxes.
- 13 Do not touch a document during printing.
- 14 Never push objects of any kind into this product through cabinet slots, since they may touch dangerous voltage points or short out parts resulting in a risk of fire or electric shock. Never spill liquid of any kind on the product.
- 15 Do not attempt to service this product yourself, as opening or removing covers may expose you to dangerous voltage points and/or other risks, and may void your warranty. Refer all servicing to a Brother Authorized Service Center. A list of Brother Authorized Service Centers has been included for your convenience, or you may contact Brother Customer Service for your nearest Brother Authorized Service Center. (See *Brother Numbers*, page i.)
- 16 Unplug this product from the wall outlet and refer servicing to a Brother Authorized Service Center under the following conditions:
  - A When the power cord is damaged or frayed.
  - B If liquid has been spilled into the product.
  - C If the product has been exposed to rain or water.

- D** If the product does not operate normally when the operating instructions are followed. Adjust only those controls that are covered by the operating instructions. Improper adjustment of other controls may result in damage and will often require extensive work by a qualified technician to restore the product to normal operation.
  - E** If the product has been dropped or the cabinet has been damaged.
  - F** If the product exhibits a distinct change in performance, indicating a need for service.
- 17** To protect your product against power surges, we recommend the use of a power protection device (Surge Protector).

# 13 Troubleshooting and Routine Maintenance

## Troubleshooting

---

If you can't resolve a difficulty with your fax machine using the Manual, please see page i for *Brother Numbers* to call for assistance.

The fax machine has a mechanical problem.  
Contact Brother Customer Service at

MACHINE ERROR XX

CALL BROTHER CS

**In USA:** 1-800-284-4329 (voice)  
1-800-284-3238 (TTY service for the hearing - impaired)

**In Canada:** 1-800-853-6660 (voice)  
1-514-685-6464 (voice) (in Montreal)











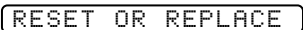

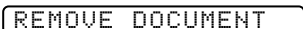
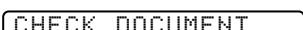
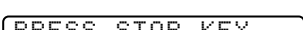

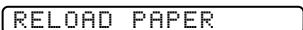

## Error Messages

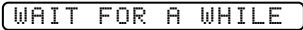
You may occasionally encounter a difficulty with your machine or telephone line. If this happens, your machine often identifies the problem and displays an error message. The list below explains the most common error messages.

You can correct most problems by yourself.

If you need additional help, call the Brother fax-back system.

ERROR MESSAGE	CAUSE/ACTION
 	The machine is out of ribbon or the print cartridge is not properly installed. Install the print cartridge again. (See <i>Replacing the Print Cartridge</i> , page 13-5.)
   	The documents were not inserted or fed properly, or were too long. (See <i>Clearing Jams</i> , page 13-3.)
 	The fax machine is out of paper or paper is not properly loaded in the paper tray. Refill the paper or remove the paper and load it again. If this error appears while receiving a fax, load paper to restart printing. If you were coping or printing reports, load paper and try again.
	A poor quality phone line resulted in a communications error. Try the call again.
	You have requested a polling call from another party, but the other fax machine is not in Poll Waiting mode. Verify the other parties polling setup.
 	The print head has overheated. Wait 30 minutes for it to cool.
 	The cover is not completely closed. Close the cover.
	The other party has disconnected during a call or fax.
 	The fax machine has a mechanical problem. Contact Brother Customer Service for assistance. (See <i>Brother Numbers</i> , page i.)
	The number you called does not answer or is busy. You may also have reached a number not connected to a fax. Check the number and call again.

ERROR MESSAGE	CAUSE/ACTION
<p>OUT OF MEMORY</p> <p>ERASE MESSAGE</p>	<p>The memory capacity has been exceeded. Print the faxes stored in memory to delete them. Then try again. (See <i>Printing a Fax Message</i>, page 9-4.)</p>
<p>OUT OF MEMORY</p> <p>PRINT:PRESS COPY</p> <p>OUT OF MEMORY</p> <p>QUIT:PRESS STOP</p>	<p>There is not enough memory available to perform your copy operation. Press <b>Stop/Exit</b>. Print the faxes stored in memory to delete them. Then try again. (See <i>Printing a Fax Message</i>, page 9-4.)—<b>OR</b>—Press <b>Stop/Exit</b> to cancel the job. Then try again. (See <i>Canceling a Scheduled Job</i>, page 6-5.)</p>
<p>OUT OF MEMORY</p> <p>SEND:PRESS START</p> <p>OUT OF MEMORY</p> <p>QUIT:PRESS STOP</p>	<p>There is not enough memory available to send your fax. Press <b>Stop/Exit</b>. Print the faxes stored in memory to delete them. Then try again. (See <i>Printing a Fax Message</i>, page 9-4.)—<b>OR</b>—Press <b>Stop/Exit</b> to cancel the job. Then try again. (See <i>Canceling a Scheduled Job</i>, page 6-5.)</p>
<p>PAPER JAM</p> <p>PLS OPEN COVER</p> <p>PAPER JAM</p> <p>REMOVE PAPER</p>	<p>The paper is jammed in the machine. (See <i>Clearing Jams</i>, page 13-3.)</p>

## Clearing Jams

The fax machine is out of paper, the paper is not properly loaded, or the paper is jammed in the fax machine.

- 1 Open the paper cover and remove any paper that is not jammed.

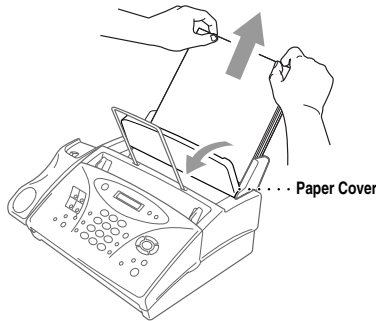

- 2** Open the front cover, and then open the top cover by pressing the blue levers on both sides of the top cover.

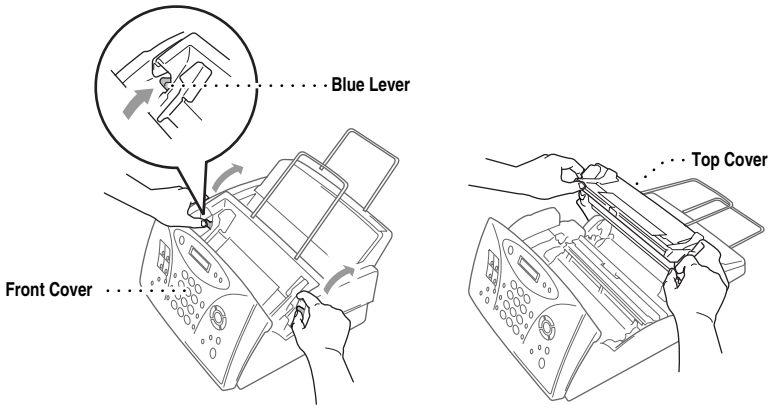

- 3** Pull the jammed paper gently from the paper feeder toward the *back* of the fax machine. If the paper remains jammed, then pull it toward the *front* of the machine.

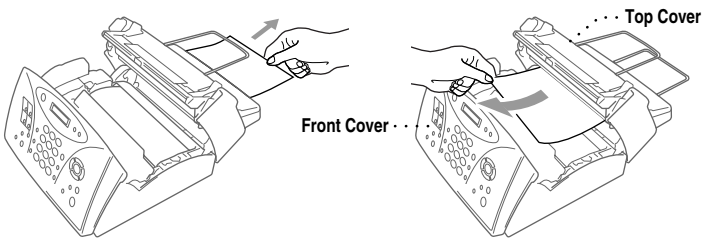

- 4** Remove the print cartridge and turn the spool clockwise to tighten the ribbon.  
**5** Re-install the cartridge.  
**6** Close the top cover.  
**7** Close the front cover.  
**8** Load the paper.

## Replacing the Print Cartridge

**Note** You can reuse the print cartridge until it breaks. If you purchased refill ribbons, follow the instructions that came with them.

- 1 Open the front cover, and then open the top cover by pressing the blue levers on both sides of the top cover.

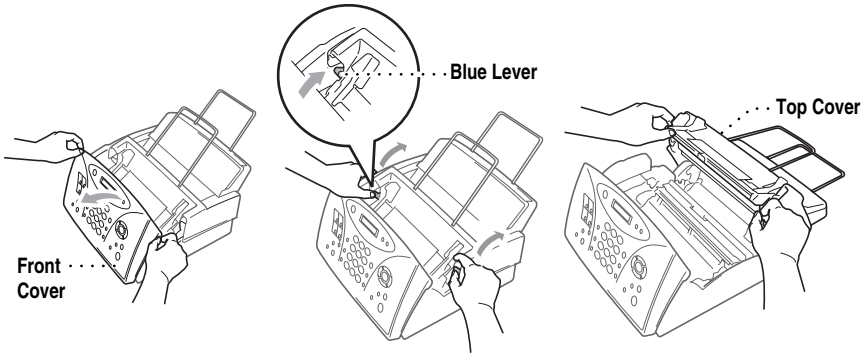

- 2 Remove the old print cartridge containing the used ribbon and dispose of it.

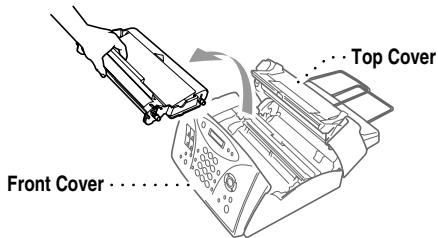

- 3 Remove the plastic stopper from the new print cartridge.

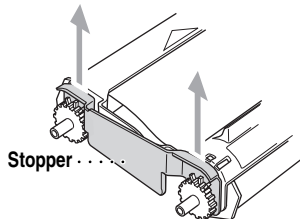

- 4 Turn the black spool on the right clockwise to tighten the ribbon as shown.

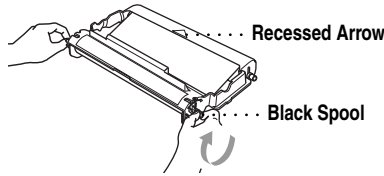

- 5 Install the new print cartridge by inserting the recessed  first and then placing the cartridge into its four holders.

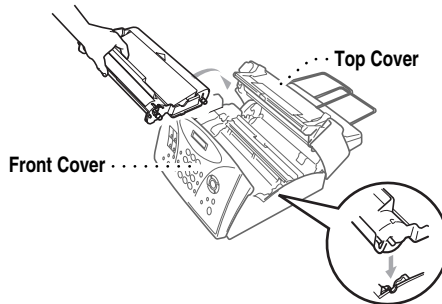

- 6 Press down on both sides of the top cover to close it securely.  
7 Close the front cover.



You can save money by purchasing the 2-PK Refill Ribbon Rolls (PC302RF). *Installation instructions will be included.* If you handle the print cartridge (frame) carefully, you can reuse it until it breaks.

## If You Are Having Difficulty with Your Fax Machine

If you think there is a problem with your fax machine, **make a copy first**. If the copy looks good, the problem is probably not your fax machine. Check the difficulties below and follow the troubleshooting tips.

### Printing or Receiving Faxes

#### Condensed Print and Horizontal Streaks; Top and Bottom of Sentences Cut Off

If your copy looks good, you probably had a bad connection, with static or interference on the phone line. If the copy looks bad, call Brother Customer Service at 1-800-284-4329 (in USA), 1-800-853-6660 (in Canada) or 1-514-685-6464 (in Montreal).

#### Vertical Black Lines When Receiving

The sender's scanner may be dirty. Ask the sender to make a copy to see if the problem is with the sending machine. Try receiving from another fax machine. If the problem continues, call Brother Customer Service at 1-800-284-4329 (in USA), 1-800-853-6660 (in Canada) or 1-514-685-6464 (in Montreal).

## Phone Line or Connections

### **Fax Machine Does Not Answer When Called**

Make sure the fax machine is in the correct receiving mode for your setup (either **FAX ONLY**, **FAX/TEL** or **MSG CTR**). Check for dial tone. If possible, call your fax machine to hear it answer. If there is still no answer, check the telephone line cord connection. (See *Connecting the Machine*, page 2-5 and *Connect the telephone line*.) Connect a *standard* telephone handset to the fax machine telephone jack. If there is no ringing when you call your fax machine, call your telephone company to check the line.

### **Telephone Answering Device (TAD) Does Not Answer When Called**

Connect the telephone line cord from your TAD to the back of the fax machine, in the jack labeled EXT. Make sure the TAD is set to answer calls. (See *Connecting an External Telephone Answering Device (TAD)*, page 2-9.)

### **No Dial Tone on the Handset**

Press **Speaker Phone**—OR—Lift the handset. If you don't hear a dial tone, check telephone line cord connections at the fax machine and wall jack. Check that the handset is connected to the fax machine's handset jack. Test the wall jack with another single line telephone. If there is no dial tone at the wall outlet, call your telephone company.

### **The Caller ID Does Not Display after the Call Waiting Signal**

The Caller ID signal is sent ten seconds after the Call Waiting Signal and speaking may interfere with it. When you hear the Call Waiting signal, ask the other party to hold while you answer the call. Then stop speaking until you see the Caller ID on the LCD.

## Sending Faxes

### **Poor Transmitting Quality**

Try changing your resolution to FINE or S. FINE. (See *Resolution*, page 6-3.) Make a copy to verify the fax machine's scanner operation.

### **Dialing Does Not Work**

Check all line cord connections, and make sure the curled handset cord is not in the EXT jack.

Check power cord connection.

Send a manual fax by pressing **Speaker Phone** or by lifting the handset and dialing the number. Wait to hear fax receiving tones before pressing **Fax Start**.

### **Vertical Black Lines When Sending**

Use your fax machine to make a copy. If the copy shows the same problem, the scanner area is dirty. Lift the top cover and check the original path. Clean the scanner's white tape and the glass strip under the tape using isopropyl alcohol and a lint-free cloth. (See *Cleaning the Scanner*, page 13-9.)

## Handling Incoming Calls

### Double-Ring in FAX/TEL Mode

The fax machine knows the incoming call is not a fax so it is signaling you to answer the telephone call. Pick up the fax machine handset or answer from an extension phone, and then press your fax machine's Telephone Answer Code (default setting is #51). (See *For FAX/TEL Mode Only*, page 5-6.)

### Transferring a Call to the Fax Machine

If you have answered the fax machine handset, press **Fax Start** and hang up immediately.

If you answered at an extension phone, press your three-digit Fax Receive Code (the factory setting is ✕51). When your fax machine answers, hang up.

### Fax Machine "Hears" Voice as CNG Tone

If your fax machine is set to Easy Receive ON, it is more sensitive to sounds. Your fax machine may mistakenly interpret certain voices or music on the line as a calling fax machine and respond with fax receiving tones. Deactivate the fax by pressing **#51** if you are at an extension phone or press **Stop/Exit** if you are at the fax machine or an external phone.

Try avoiding this problem by turning Easy Receive to OFF. (See *Easy Receive*, page 5-4.)

### Transmission Verification Report Prints "Result: NG"

There is probably temporary noise or static on the phone line. Try sending the fax again. If the problem continues, call the telephone company to check your phone line.

### Custom Features on a Single Line

If you have Call Waiting, RingMaster, Voice Mail, an answering machine, alarm system or any other custom feature on a single phone line with your fax machine, it may create a problem sending or receiving fax data.

For Example :

Your Brother machine handles the Caller ID and Call Waiting/Caller ID subscriber services. However, if you subscribe to *only* Call Waiting or some other custom service and its signal comes through the line while your machine is sending or receiving a fax, the signal can temporarily interrupt or disrupt the fax data. Brother's ECM feature should help overcome this problem. This condition is related to the telephone system industry and is common to all devices that send and receive information on a single, shared line with custom features. If avoiding a slight interruption is crucial to your business, a separate line with no custom features is recommended.

Using Call Waiting Caller ID:

If you are having a telephone conversation and a fax communication signal comes through on Call Waiting Caller ID, you can verify that the second call is a fax by switching to it. You have the option to receive the fax call, by asking the first caller to hang up to clear the line.

# Routine Maintenance

---

## Cleaning the Scanner

Before cleaning, unplug the power cord for safety. Clean the white bar and the glass strip under the bar with isopropyl alcohol on a lint-free cloth. Be careful not to bend the spring plate or drop anything into the fax machine.

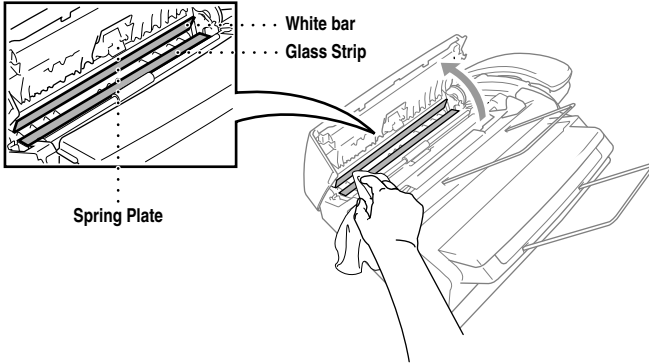

## Cleaning the Print Head

Before cleaning, unplug the power cord for safety. To clean the fax machine print head, wipe the metal and plastic part with a lint-free cloth that is dry or lightly moistened with isopropyl alcohol.

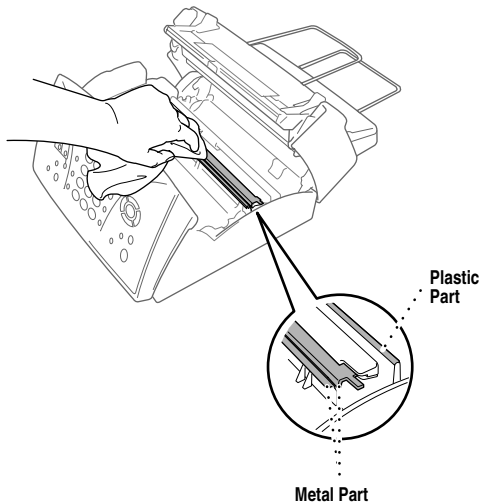



## Packing and Shipping the Fax Machine

---

Whenever you transport the fax machine, use the packing materials that came with your fax machine. If you do not pack the fax machine correctly, you could void your warranty.

- 1 Unplug the fax machine from the AC outlet.

**Note** Do not unplug the fax machine after a print job until you hear the final click.

- 2 Remove the paper wire extension, document support, telephone line cord and handset, and pack them.

**Note** If you are returning the fax machine to Brother as part of the Brother Exchange Service, pack *only* the fax machine. Keep all separate parts to use with your “Exchange” machine.

- 3 Wrap the fax machine in the plastic bag and place it in the original carton with the original packing material.

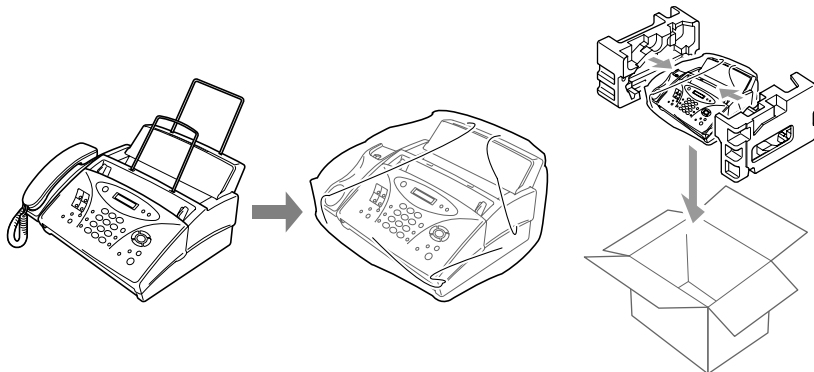

# Specifications

<b>Type</b>	Desktop Facsimile Transceiver
<b>Compatibility</b>	ITU-T Group 3
<b>Coding System</b>	Modified Huffman (MH)
<b>Modem Speed</b>	14400/12000/9600/7200/4800/2400; Automatic Fallback
<b>Original Input Width</b>	5.8 inches to 8.5 inches (148 mm to 216 mm)
<b>Scanning/Printing Width</b>	8.2 inches (208 mm)
<b>Automatic Document Feeder (ADF)</b>	up to 10 pages
<b>Paper Tray</b>	100 Sheets
<b>Printer Type</b>	Line Thermal with Ribbon
<b>Gray Scale</b>	64 levels (Dithered)
<b>Display</b>	LCD, 16 characters
<b>Polling Types</b>	Standard, Sequential
<b>Contrast Control</b>	Automatic/Super Light/Super Dark (manual setting)
<b>Resolution</b>	<ul style="list-style-type: none"><li>• Horizontal 203 dot/inch (8 dot/mm)</li><li>• Vertical Standard—98 line/inch (3.85 line/mm) Fine, Photo—196 line/inch (7.7 line/mm) Superfine, Photo (copy)—392 line/inch (15.4 line/mm)</li></ul>
<b>Memory Capacity</b>	512 KB (up to 25 pages*)
<b>One Touch Dial</b>	8 (with Shift key)
<b>Speed Dial</b>	50 stations
<b>Automatic Redial</b>	3 times at 5 minute intervals
<b>Speaker Type</b>	Full Duplex, Digital
<b>Auto Answer</b>	0, 1, 2, 3 or 4 rings
<b>Communication Source</b>	Public switched telephone network
<b>Operating Environment</b>	41 - 95° F
<b>Power Source</b>	120V AC 50/60Hz (U.S.A., Canadian Version Only)
<b>Power Consumption</b>	Standby: under 5 watts — Peak: under 170 watts
<b>Dimensions</b>	12.3 × 13.6 × 7.3 (inches)/ 307 × 341 × 182 (mm)
<b>Weight</b>	9.5 lb / 4.3 kg
<b>Refill Ribon Rolls</b>	Yield : up to 250 pages (Letter)

\* "Pages" refers to the ITU-T #1 chart (in Out of Paper Reception in ECM mode).  
Specifications are subject to change without prior notice.

# Index

## A

Accessories .....	ii
Alternating Displays .....	3-1
Answering Machine.....	2-9
Automatic Transmission.....	6-2

## B

Beeper Volume .....	4-5
Broadcasting .....	7-6
Broadcasting (Set Up Groups).....	7-3
Brother Numbers .....	i

## C

Call Waiting Caller ID.....	8-6
Caller ID (Printing Log) .....	8-4
Caller ID (Viewing Log) .....	8-4
Canceling Job .....	6-5
Chain Dialing.....	7-2
Connect (External Telephone Answering Device).....	2-9
Connect (External Telephone).....	2-10
Connect (Power Cord) .....	2-5
Connect (Telephone Line) .....	2-5
Contrast.....	6-3
Control Panel .....	1-2
COPY (Multiple) .....	10-2
copy(ies) scannable area .....	10-1
Corrections (Entering Text).....	4-3
Customer Service.....	i

## D

Date and Time .....	4-1
Delayed Fax .....	6-4
Dialing Mode.....	4-6
Dialing Options.....	7-4

Disclaimer & Warranties .....	iii
Distinctive Ring .....	8-1
Documents (Size).....	6-1

## E

Easy Receive.....	5-4
ECM (Error Correction Mode) .....	1-5
Entering Text .....	4-2
Error Messages .....	13-2
External Telephone.....	2-10
External Telephone Answering Device ..	2-9

## F

F/T (FAX/TEL) Mode .....	5-1
F/T Ring Time .....	5-3
FAX ONLY Mode.....	5-1
Fax Receive Code .....	5-6
Fax Tones and Handshake .....	1-4
fax-back system .....	i
Fine (Resolution) .....	6-3
Frequently Asked Questions (FAQs).....	i

## G

Gray Scale.....	S-1
-----------------	-----

## H

Handset Volume .....	4-4
Help.....	1-1
Hold .....	1-2, 7-7
<a href="http://www.brother.com">http://www.brother.com</a> .....	i

## I

Ident-a-Call.....	8-1
Inserting Spaces .....	4-2
International Calls.....	6-4
Interrupting .....	6-5

## L

LCD (Liquid Crystal Display) .....3-1

## M

Maintenance (Routine) ..... 13-9

Manual Dialing .....7-4

MANUAL Mode .....5-1

Manual Transmission.....6-2

Memory Storage .....4-6

Memory Transmission .....6-3

MSG CTR (Mode).....5-1

Multi-Line Connections.....2-7

## O

One Touch Dial (Changing) .....7-3

One Touch Dial (Storing) .....7-1

One Touch Dialing .....7-4

On-Screen Programming .....3-1

Outgoing Message (External TAD).....2-10

Overseas Mode .....6-4

## P

Paper Size .....5-5

Pause .....7-7

PBX.....2-7

Photo (Resolution).....6-3

Polled Transmit.....6-5

Polling (Receive) .....5-7

Power Consumption.....S-1

Print (a fax in memory).....9-4

Print (Caller ID Log) .....8-4

Print Head (Cleaning) .....13-9

Pulse (For Canada Only) .....4-6

## R

Receive Mode ..... 5-1, 5-2

Redial (Automatic) .....6-2

Redial (Manual).....6-2

Reduction (Printing) .....5-4

Reduction (Recommended Ratios) .....5-5

Remote Codes (Changing).....5-6

Reports types of .....11-1

Resolution .....6-3

Ring Delay .....5-2

Ring Volume.....4-5

RingMaster .....8-1

Roll Over Phone Lines.....2-6

## S

Safety Instructions .....12-3

Scanner (Cleaning) .....13-9

Search .....7-6

SmartRing .....8-1

Speaker Volume.....4-4

Special characters .....4-3

Speed Dial (Changing) .....7-3

Speed Dial (Storing) .....7-2

Speed Dialing.....7-5

Standard (Resolution) .....6-3

Station ID.....4-1

Storing Telephone Numbers .....7-1

Super Fine (Resolution).....6-3

## T

TAD .....2-9

Teen-Ring .....8-1

Telephone Answer Code.....5-6

Telephone Numbers .....7-1

Tone .....4-6

Tone (Send Signals).....7-7

Transmission Verification (Xmit)  
Report.....11-2

Two-Line Phone System.....2-6

## V

Voice Mail .....1-4

Volume Amplify .....4-5

## **W**

WARNING ..... 12-2



# Remote Retrieval Access Card

If you plan to retrieve voice or fax messages while away from your fax machine carrying the Remote Retrieval Access Card printed below will serve as a convenient reminder of the retrieval procedures. Simply cut out the card and fold it to fit in your wallet or organizer. Keeping it handy will help you derive the full benefit of your fax machine's forwarding, paging and remote retrieval features.

## Changing Remote Retrieval Access Code

- 1 Press **Menu/Set**, 8, 7.
- 2 Enter a three-digit number, from 000 to 999. The \* cannot be changed.
- 3 Press **Menu/Set**.
- 4 Press **Stop/Exit**.

## Remote Commands Listen to Voice Messages

- Press 9, 1.
- then to*
- Repeat a message, press 1.
  - Skip to next message, press 2.
  - Stop playing the message, press 9.

## Record a Memo

- Press 9, 2.
- Wait for the beep, then speak.
- then to* Stop recording Press 9.

## Erase All Messages

Press 9, 3. If you hear three beeps, all messages have not yet been played, and the system will not erase.

## Play/Record Outgoing Message

- Press 9, 4.
- then to*
- Play Message Center-OGM, press 1, 1.
  - Play/EFT OGM, press 1, 2.
  - Record new Message Center OGM, press 2, 1, then speak after beep. Press 9 to stop.
  - Record new EFT OGM, press 2, 2, and then speak after beep.
  - Press 9 to stop.

## Change Paging/Fax Forwarding Setting

- Press 9, 5.
- then to*
- Turn feature off, press 1.
  - Enter Fax Forwarding Number, press 2.
  - Enter Paging Number, press 3.
  - Program Fax Forward Number, press 4. Enter the new number of the remote fax machine where you want your fax messages forwarded and then press # #. After two short beeps, press 9, 6, 1. To retrieve a Memory Status List, enter the number of the remote fax machine followed by # #.

## Retrieve a Fax

- Press 9, 6.
- then to*
- Print a Memory Status List, press 1, enter the number of remote fax machine followed by # #. After the beep, hang up and wait.

Retrieve all faxes, press **2**, then enter the number of remote fax machine followed by **#**. After the beep, hang up and wait. Erase all fax messages, press **3**.

### Check Receiving Status

Press **9 7**,  
*then for* Fax message, press **1**.  
Voice message, press **2**.  
1 long beep — Received message  
3 short beeps — No messages

### Change Answer Mode

Press **9 8**,  
*then for* Message Center, press **1**.  
FAX/T telephone (FTT), press **2**.  
Fax Only, press **3**.

### Exit Remote Retrieval

Press **9 0**.

### MESSAGE CENTER REMOTE RETRIEVAL ACCESS CARD

#### Using Remote Access Code

- 1 Dial your fax number from a fax machine using touch tone.
- 2 When your fax machine answers, immediately enter your Remote Retrieval Access Code (159 \*).
- 3 Your FAX signals the kinds of messages received:  
1 long beep — Fax message(s)  
2 long beeps — Voice message(s)  
3 long beeps — Fax and Voice  
No beeps — No messages
- 4 After 2 short beeps, enter a command. Press **9 0** to reset the FAX when you finish.
- 6 Hang up.

5

6

7



## **EQUIPMENT ATTACHMENT LIMITATIONS (For Canada Only)**

### **NOTICE:**

The industry Canada label identifies certified equipment. This certification means that the equipment meets telecommunications network protective, operational and safety requirements as prescribed in the appropriate Terminal Equipment Technical Requirements document(s). The Department does not guarantee the equipment will operate to the user's satisfaction.

Before installing this equipment, users should ensure that it is permissible to be connected to the facilities of the local telecommunications company. The equipment must also be installed using an acceptable method of connection. The customer should be aware that compliance with the above conditions may not prevent degradation of service in some situations.

Repairs to certified equipment should be coordinated by a representative designated by the supplier. Any repairs or alterations made by the user to this equipment, or equipment malfunctions, may give the telecommunications company cause to request the user to disconnect the equipment.

Users should ensure for their own protection that the electrical ground connections of the power utility, telephone lines and internal metallic water pipe system, if present, are connected together. This precaution may be particularly important in rural areas.

### **Caution:**

Users should not attempt to make such connections themselves, but should contact the appropriate electric inspection authority, or electrician, as appropriate.

### **NOTICE:**

The Ringer Equivalence Number (REN) assigned to each terminal device provides an indication of the maximum number of terminals allowed to be connected to a telephone interface. The termination on an interface may consist of any combination of devices subject only to the requirement that the sum of the Ringer Equivalence Numbers of all the devices does not exceed 5 REN=0.2B

# brother®

Brother International Corporation  
100 Somerset Corporate Boulevard  
P.O. Box 6911  
Bridgewater, NJ 08807-0911 USA

Brother International Corporation (Canada) Ltd.  
1 rue Hôtel de Ville,  
Dollard-des-Ormeaux, QC, CANADA H9B 3H6

**Visit us on the World Wide Web**  
**<http://www.brother.com>**

These machines are made for use in the USA or CANADA only. We can not recommend using them overseas because it may violate the Telecommunications Regulations of that country and the power requirements of your fax machine may not be compatible with the power available in foreign countries. **Using USA or CANADA models overseas is at your own risk and will void your warranty .**